

West Boldon Primary's Calculation Policy 2025-26



Michael Wilson

The Policy in Context

This policy is a working document and will be revised and amended as necessary. Many variations have been included to provide teachers with a range of tools to support pupils in their grasp of number and calculation. Written methods are complementary to mental methods and should not be seen as separate from them. The aim is that children use mental methods when appropriate, but for calculations that they cannot do in their heads they use an efficient written method accurately and with confidence. It is important that children acquire secure mental methods of calculation and one efficient written method of calculation for addition, subtraction, multiplication and division which they know they can rely on when mental methods are not appropriate.

Maths assessments are administered once every term to monitor the children's progress. The assessments are provided by the class teacher to identify the children's strengths and areas for improvement. The overall judgement of a child's abilities is based on their maths assessments as well as teacher judgement. The assessments are completed with no manipulatives as we encourage the children to be individual and independent learners. Using our CPA (concrete, pictorial and abstract) approach, we strive to ensure that our children develop their mathematical abilities. The assessments allow us as teachers and as a school to monitor areas of development to ensure the delivery of first class teaching and put in place suitable interventions where necessary.

***Power Maths* calculation policy, Reception**

The following pages show the *Power Maths* progression in calculation (addition, subtraction, multiplication and division). The consistent use of the CPA (concrete, pictorial, abstract) approach across *Power Maths* helps children develop mastery across all the operations in an efficient and reliable way. In Reception, children focus on concrete and pictorial representations. At this stage, children focus on representing objects in different ways e.g. understanding that 5 cars can also be represented as 5 counters, 5 cubes, 5 pictures of cars, etc.

In Reception, children are encouraged to record their findings in their own way. This may include writing number sentences e.g. $3 + 4 = 7$, however this is not a requirement until Year 1.





Power Maths calculation policy Reception

Children develop the core ideas that underpin all calculation. They begin by connecting calculation with counting on and counting back, but they should learn that understanding wholes and parts will enable them to calculate efficiently and accurately, and with greater flexibility. Children record their calculations in their own ways, there is no expectation of number sentences at this stage, however children may choose this way to record their thinking.

Key language: count, forwards, backwards, whole, part, recombine, break apart, ones, ten, tens, number bond, add, adding together, addition, plus, total, altogether, first, then, now, subtract, subtraction, find the difference, take away, minus, left, less, more, fewer, group, share, equal, equals, is equal to, groups, equal groups, divide, share, shared equally

Addition:	Subtraction:	Multiplication and Division:
<p>Children start to explore addition by sorting groups. They then use sorting to develop their understanding of parts and wholes.</p> <p>Children combine groups to find the whole, using a part-whole model to support their thinking. They also use the part-whole model to find number bonds within and to 10.</p> <p>Using a five frame and ten frame, children add by counting on. They start by finding one more before adding larger numbers using counters or cubes on the frames.</p> <p>Children use a number track to add by counting on. Linking this learning to playing board games is an effective way to support children's addition.</p>	<p>Children start to explore subtraction by sorting groups. They use sorting to develop their understanding of parts and wholes.</p> <p>When comparing groups, children use the language more than and fewer than. This will lead to finding the difference when they move into KS1.</p> <p>Children then connect subtraction with the idea of counting back and finding one less using a five frame to support their thinking.</p> <p>They explore subtraction by breaking apart a whole to find a missing part. This links to their developing recall of number bonds.</p> <p>Children count back within 20 using number tracks and ten frames to see the effect of taking away.</p>	<p>Children first start to look at the idea of equal groups through their exploration of doubles. They use five frames and objects to check that groups are equal.</p> <p>Children then explore halving numbers by making two equal groups. They highlight patterns between doubling and halving seeing that double 2 is 4 and half of 4 is 2.</p> <p>As well as halving, children also explore sharing into more than two equal groups. They share objects one by one, ensuring that each group has an equal share.</p>

Reception

	Real-life representation	Other representations
<p>Addition</p>	<p>Counting and adding more (within 5)</p> <p>Children add one more person or object to a group to find one more.</p>  <p><i>One more than 3 is 4.</i></p>	<p>Counting and adding more (within 5)</p> <p>Children represent first, then, now stories on a five frame. They make the first number and then add one more.</p> <p>First</p>  <p>Then</p>  <p>Now</p>  <p><i>First, there are 3 bikes. Then, 1 more bike came. Now, there are 4 bikes.</i></p>

Combining groups to find the whole

Children sort people and objects into parts and combine them to find the whole.



The parts are 3 and 4. The whole is 7.

Combining groups to find the whole

Children use counters or cubes in a part-whole model to find the whole.

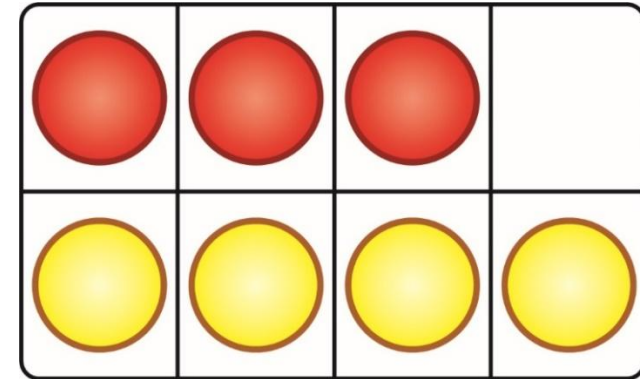

The parts are 3 and 4. The whole is 7.

Finding number bonds to 10

Children combine two groups to find a number bond to 10.

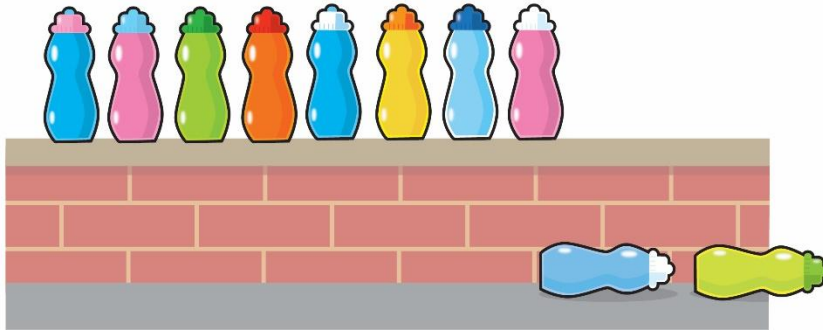

*There are 8 bottles on the wall.
There are 2 bottles on the floor.
There are 10 bottles altogether.*

Finding number bonds to 10

Use ten frames and part-whole models to represent key number bonds.

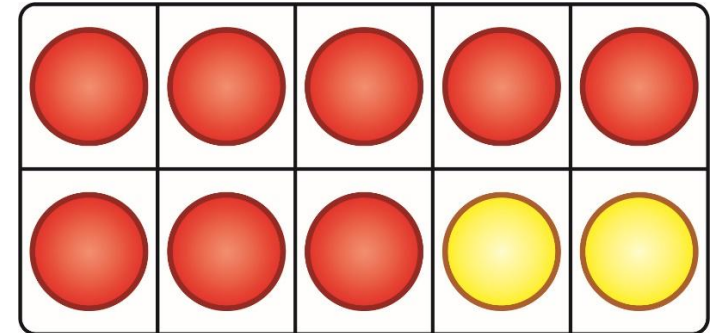

*8 and 2 is 10.
There are 10 altogether.*

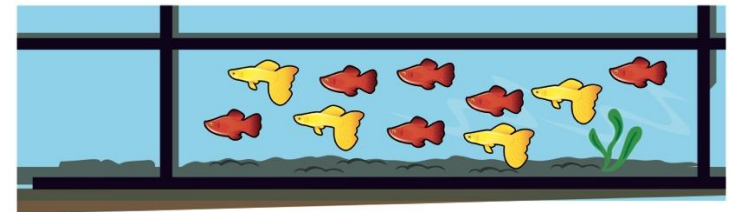

*6 and 4 is 10.
There are 10 altogether.*

Adding by counting on (number track)

Children jump along a physical number track. They start at the larger number and count on the smaller number to find the total.



Adding by counting on (number track)

Children use a number track and a counter. They start at the larger number and count on the smaller number to find the total.

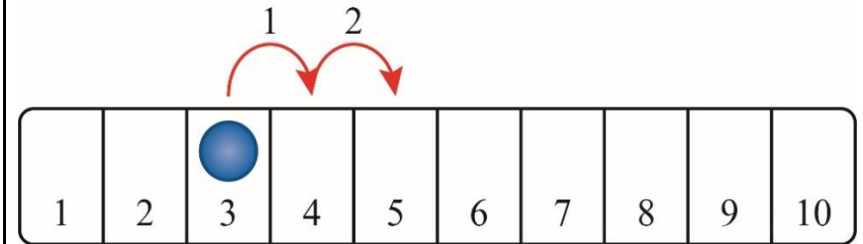

Adding by counting on (ten frames)

Children find the total number by counting on from the larger number.

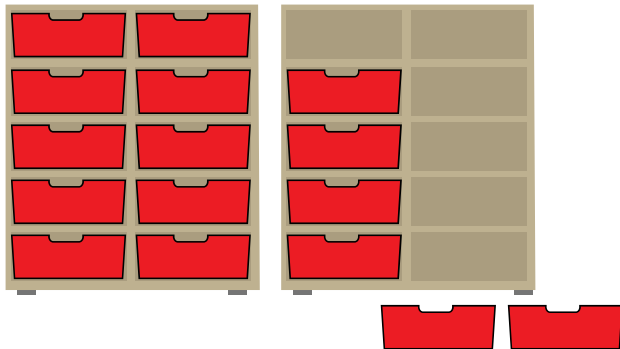

Adding by counting on (ten frames)

Children make the larger number on the ten frames and then make the smaller number, counting on to find the total. They can use counters, cubes or other objects on the ten frames.

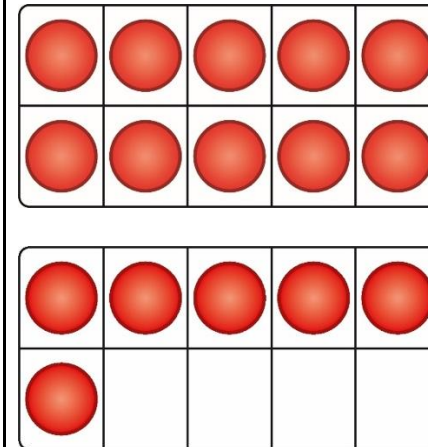

Sorting groups (optional)

Children sort everyday objects into groups.



Subtraction

Comparing groups

Children line up objects to compare the amount. They line the objects up either horizontally or vertically.



Ella has more conkers.

Tom has fewer conkers.

Comparing groups

Children line up cubes or counters to compare the amount in each group. Lines can either be horizontal or vertical. A starting line helps to line the objects accurately.

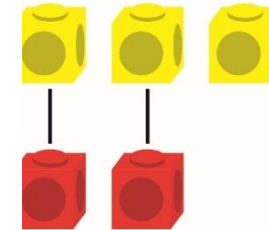

There are more yellow cubes.

There are fewer red cubes.

Counting back and taking away (within 5)

Children remove one more person or object from a group to find one less.



First, there were 3 children.

Then, 1 child left.

Now, there are 2 children.

Counting back and taking away (within 5)

Children use five frames and objects to make a number. They then remove or cross out one object to find one less.

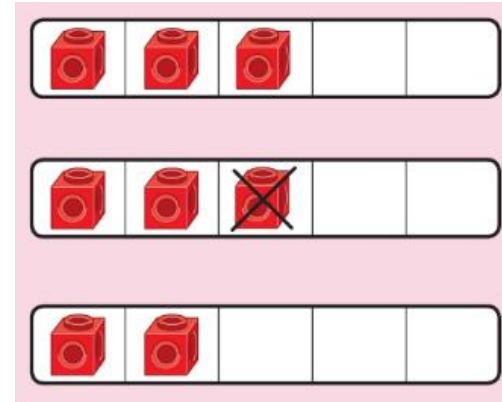



One less than 3 is 2.

Introducing the part-whole model

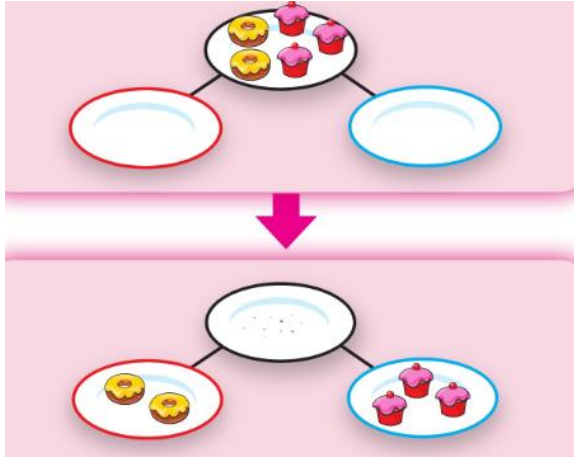
Children sort everyday objects into parts.



One part is the 

The other part is the 

Introducing the part-whole model

Children use counters or cubes to represent objects in a part-whole model.

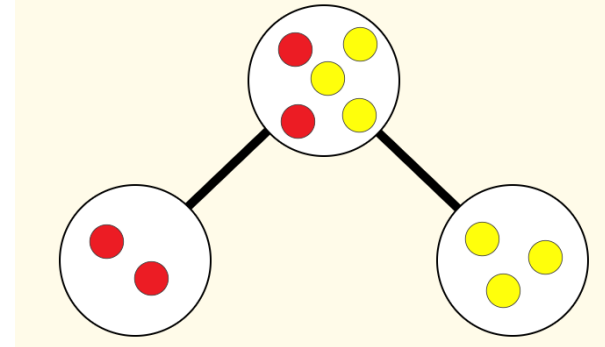

The whole is 5.

2 is a part.

3 is a part.

Finding number bonds to 10

Children partition 10 into different groups to find the number bonds to 10.

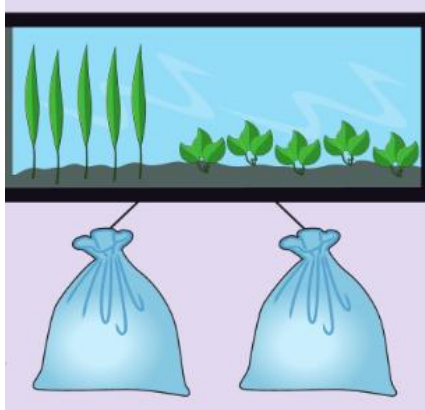

Children begin to work with subtraction number bonds. They break apart 10 to identify different number bonds to 10.



*10 are bouncing.
2 get off.
8 are left.
 $10 - 2 = 8$*

Finding number bonds to 10

Children use part-whole models, ten frames and counters to find the number bonds to 10.

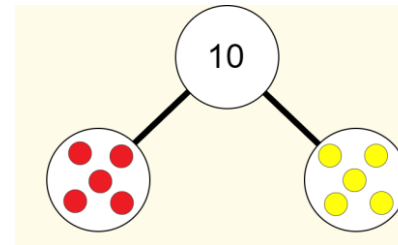

*10 is the whole.
5 is a part and 5 is a part.*

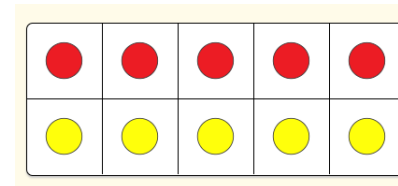

*10 is the whole.
5 is a part and 5 is a part.*

Children use part-whole models, and counters to find missing parts and the subtraction number bonds to 10.

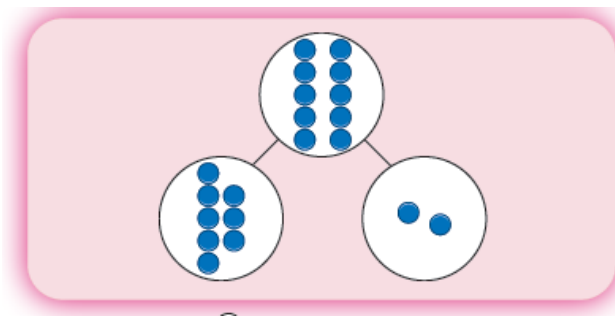

*The parts are 8 and 2.
10 is the whole.*

Counting back and taking away (number track)

Children use game boards and human number tracks to subtract by counting back.

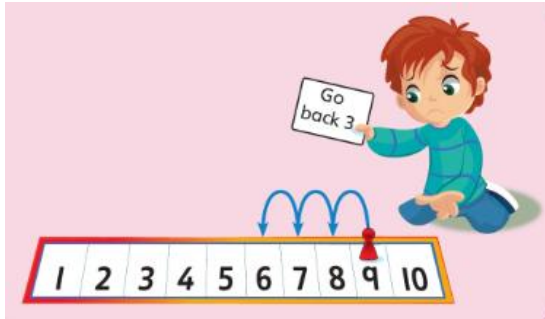

9 take away 3 equals 6

9...8...7...6

Counting back and taking away (number track)

Children use a number track and a counter. They start at the larger number and count back the smaller number to find the answer.

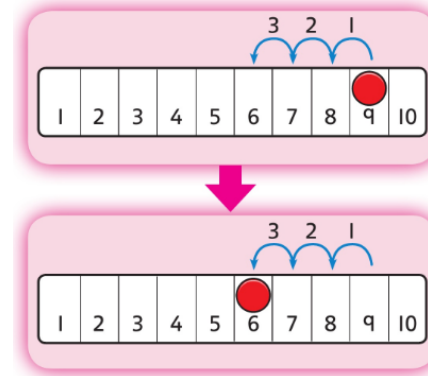

9 take away 3 equals 6

9...8...7...6

Counting back and taking away (ten frames)

Children count backwards to find one less with numbers up to 20.

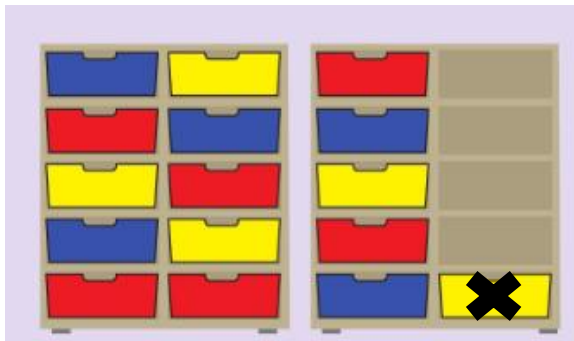

One less than 16 is 15.

Counting back and taking away (ten frames)

Children remove counters from ten frames to support in counting back with numbers up to 20.

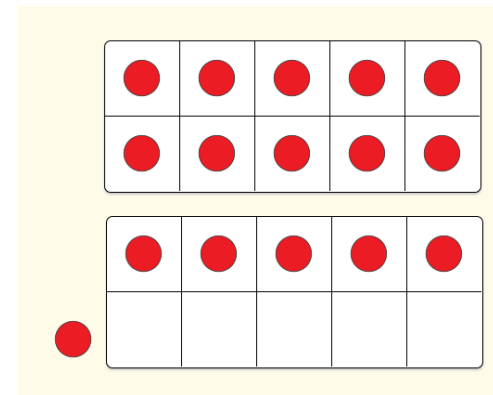

One less than 16 is 15.

Sorting groups (optional)

Children sort everyday objects into groups.



Multiplication

Making doubles

Children explore doubles in their environment including in games such as on dominoes or dice. They focus on the understanding of doubles being 2 equal groups.



*Double 4 is 8.
Double 2 is 4.
Double 3 is 6.*

Making doubles

Children use five frames to find doubles by lining up counters or cubes.

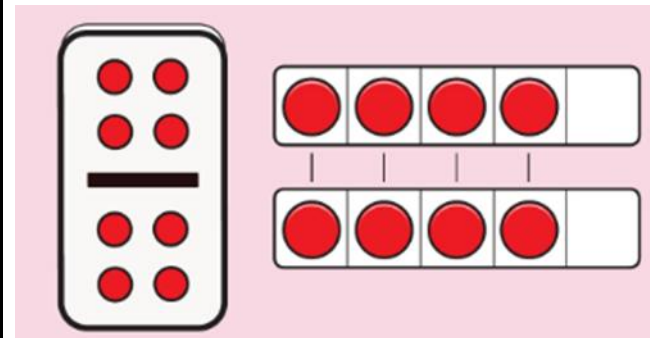

Double 4 is 8.

Division

Halving and sharing

Children explore halving and sharing through practical sharing using real life scenarios including sharing fruit or classroom equipment.

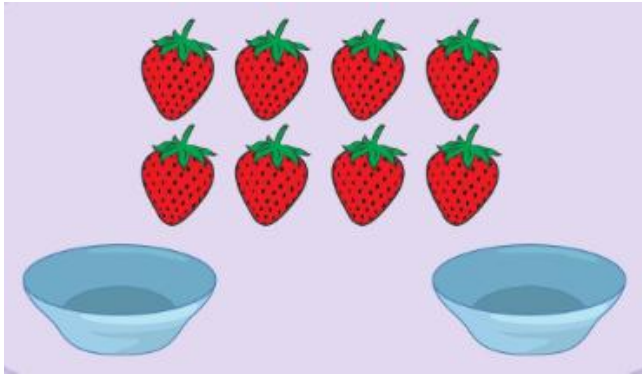

Half of 8 is 4.

Halving and sharing

Children use five frames to share amounts fairly and to check that the groups are equal. They share the counters/cubes one by one.

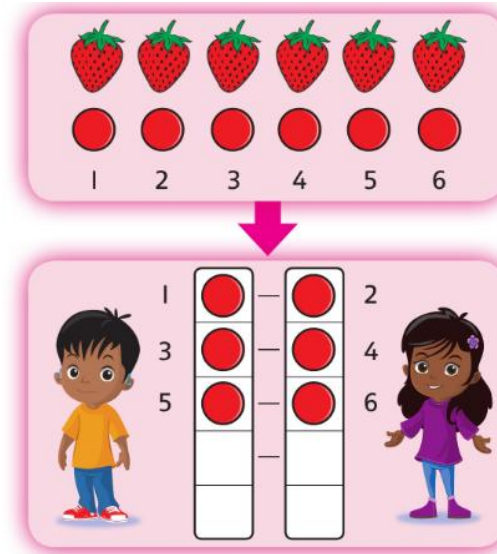

Half of 6 is 3.

The following pages show the *Power Maths White Rose Edition* progression in calculation (addition, subtraction, multiplication and division) and how this works in line with the National Curriculum. The consistent use of the CPA (concrete, pictorial, abstract) approach across *Power Maths White Rose Edition* helps children develop mastery across all the operations in an efficient and reliable way. This policy shows how these methods develop children's confidence in their understanding of both written and mental methods.

KEY STAGE 1

Children develop the core ideas that underpin all calculation. They begin by connecting calculation with counting on and counting back, but they should learn that understanding wholes and parts will enable them to calculate efficiently and accurately, and with greater flexibility. They learn how to use an understanding of 10s and 1s to develop their calculation strategies, especially in addition and subtraction.

Key language: whole, part, ones, ten, tens, number bond, add, addition, plus, total, altogether, subtract, subtraction, find the difference, take away, minus, less, more, group, share, equal, equals, is equal to, groups, equal groups, times, multiply, multiplied by, divide, share, shared equally, times-table

Addition and subtraction: Children first learn to connect addition and subtraction with counting, but they soon develop two very important skills: an understanding of parts and wholes, and an understanding of unitising 10s, to develop efficient and effective calculation strategies based on known number bonds and an increasing awareness of place value. Addition and subtraction are taught in a way that is interlinked to highlight the link between the two operations.

A key idea is that children will select methods and approaches based on their number sense. For example, in Year 1, when faced with $15 - 3$ and $15 - 13$, they will adapt their ways of approaching the calculation appropriately. The teaching should always emphasise the importance of mathematical thinking to ensure accuracy and flexibility of approach, and the importance of using known number facts to harness their recall of bonds within 20 to support both addition and subtraction methods.

Multiplication and division: Children develop an awareness of equal groups and link this with counting in equal steps, starting with 2s, 5s and 10s. In Year 2, they learn to connect the language of equal groups with the mathematical symbols for multiplication and division.

They learn how multiplication and division can be related to repeated addition and repeated subtraction to find the answer to the calculation.



In this key stage, it is vital that children explore and experience a variety of strong images and manipulative representations of equal groups, including concrete experiences as well as abstract calculations.



Children begin to recall some key multiplication facts, including doubles, and an understanding of the 2, 5 and 10 times-tables and how they are related to counting.



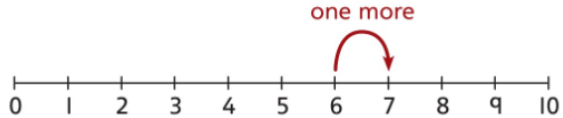
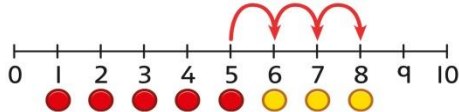

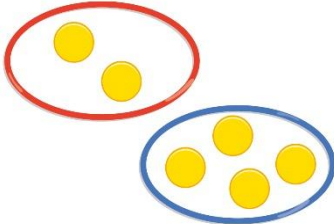
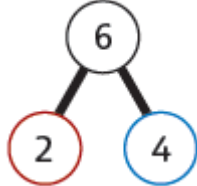

Fractions: In Year 1, children encounter halves and quarters, and link this with their understanding of sharing. They experience key spatial representations of these fractions, and learn to recognise examples and non-examples, based on their awareness of equal parts of a whole.

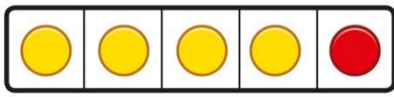
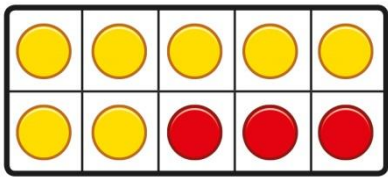
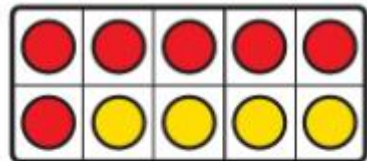
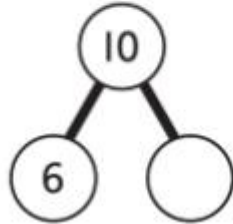
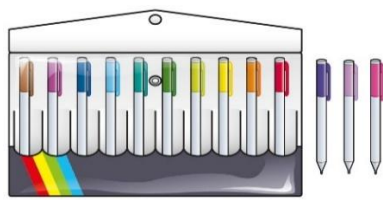
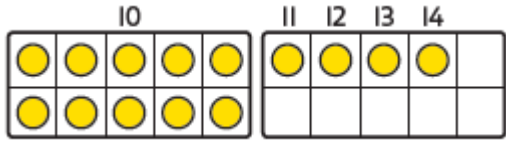
In Year 2, they develop an awareness of unit fractions and experience non-unit fractions, and they learn to write them and read them in the common format of numerator and denominator.

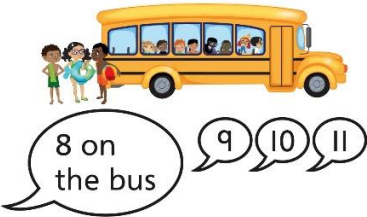
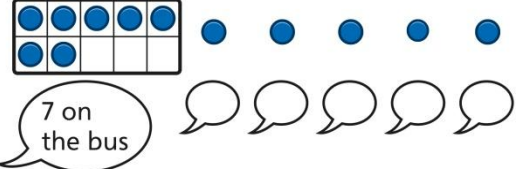
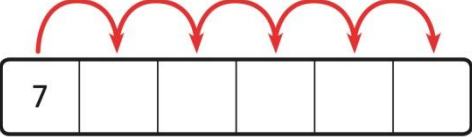
Year 1

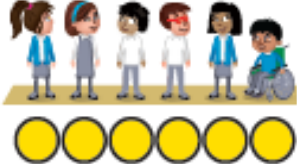
	Concrete	Pictorial	Abstract
Year 1 Addition			
Counting and adding more	<p>Children add one more person or object to a group to find one more.</p>	<p>Children add one more cube or counter to a group to represent one more.</p>  <p><i>One more than 4 is 5.</i></p>	<p>Use a number line to understand how to link counting on with finding one more.</p>  <p><i>One more than 6 is 7. 7 is one more than 6.</i></p> <p>Learn to link counting on with adding more than one.</p>  <p>$5 + 3 = 8$</p>
Understanding part-part-whole relationship	<p>Sort people and objects into parts and understand the relationship with the whole.</p>  <p><i>The parts are 2 and 4. The whole is 6.</i></p>	<p>Children draw to represent the parts and understand the relationship with the whole.</p>  <p><i>The parts are 2 and 4. The whole is 6.</i></p>	<p>Use a part-whole model to represent the numbers.</p>  <p>$2 + 4 = 6$</p>

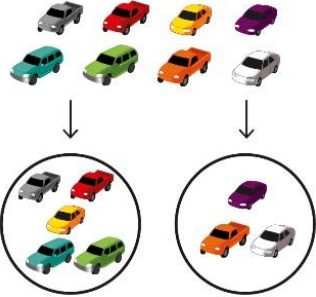
<p>Knowing and finding number bonds within 10</p>	<p>Break apart a group and put back together to find and form number bonds.</p>  <p>$3 + 4 = 7$</p>  <p>$6 = 2 + 4$</p>	<p>Use five and ten frames to represent key number bonds.</p>  <p>$5 = 4 + 1$</p>  <p>$10 = 7 + 3$</p>	<p>Use a part-whole model alongside other representations to find number bonds.</p>   <p>Make sure to include examples where one of the parts is zero.</p>
<p>Understanding teen numbers as a complete 10 and some more</p>	<p>Complete a group of 10 objects and count more.</p>  <p><i>13 is 10 and 3 more.</i></p>	<p>Use a ten frame to support understanding of a complete 10 for teen numbers.</p>  <p><i>14 is 10 and 4 more.</i></p>	<p><i>1 ten and 5 ones equal 15.</i> $10 + 5 = 15$</p>
<p>Adding by counting on</p>	<p>Children use knowledge of counting to 20 to find a total by counting on using people or objects.</p>	<p>Children use counters to support and represent their counting on strategy.</p>	<p>Children use number lines or number tracks to support their counting on strategy.</p>

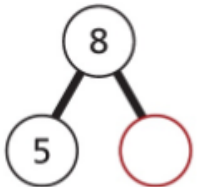
			 $7 + 5 = \square$
Year 1 Subtraction			
Counting back and taking away	<p>Children arrange objects and remove to find how many are left.</p>  <p><i>1 less than 6 is 5. 6 subtract 1 is 5.</i></p>	<p>Children draw and cross out or use counters to represent objects from a problem.</p>  <p>Now there are 6 children.</p>	<p>Children count back to take away and use a number line or number track to support the method.</p>  $9 - 3 = 6$
Finding a missing part, given a whole and a part	<p>Children separate a whole into parts and understand how one part can be found by subtraction.</p>  $8 - 5 = ?$	<p>Children represent a whole and a part and understand how to find the missing part by subtraction.</p>  $5 - 4 = \square$	<p>Children use a part-whole model to support the subtraction to find a missing part.</p>  $8 - 5 = ?$ <p>Children develop an understanding of the relationship between addition and subtraction facts in a part-whole model.</p>

Finding the difference	<p>Arrange two groups so that the difference between the groups can be worked out.</p> <p>8 is 2 more than 6. 6 is 2 less than 8. The difference between 8 and 6 is 2.</p>	<p>Represent objects using sketches or counters to support finding the difference.</p> <p>$5 - 4 = 1$ The difference between 5 and 4 is 1.</p>	<p>Children understand 'find the difference' as subtraction.</p> <p>$10 - 4 = 6$ The difference between 10 and 6 is 4.</p>
Year 1 Multiplication			
Recognising and making equal groups	<p>Children arrange objects in equal and unequal groups and understand how to recognise whether they are equal.</p> <p>A B C </p>	<p>Children draw and represent equal and unequal groups.</p> <p>A B </p>	<p>Three equal groups of 4. Four equal groups of 3.</p>
Finding the total of equal groups by counting in 2s, 5s and 10s	<p>There are 5 pens in each pack ... 5...10...15...20...25...30...35...40...</p>	<p>100 squares and ten frames support counting in 2s, 5s and 10s.</p>	<p>Use a number line to support repeated addition through counting in 2s, 5s and 10s.</p>

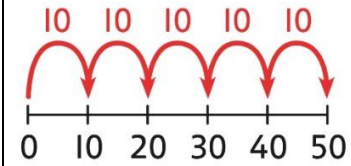
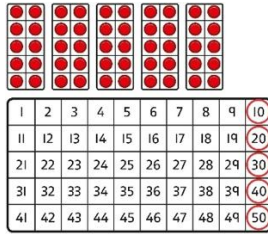

**Year 1
Division**

Grouping

Learn to make equal groups from a whole and find how many equal groups of a certain size can be made.

Sort a whole set people and objects into equal groups.



*There are 10 children altogether.
There are 2 in each group.
There are 5 groups.*

Represent a whole and work out how many equal groups.

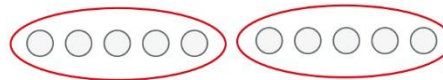

*There are 10 in total.
There are 5 in each group.
There are 2 groups.*

Children may relate this to counting back in steps of 2, 5 or 10.

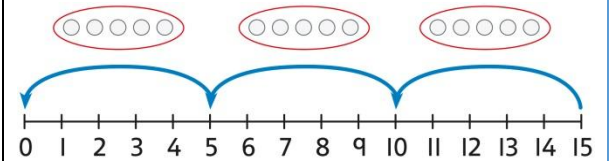

Sharing

Share a set of objects into equal parts and work out how many are in each part.

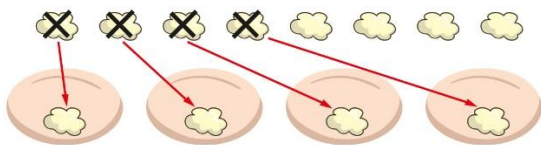

Sketch or draw to represent sharing into equal parts. This may be related to fractions.

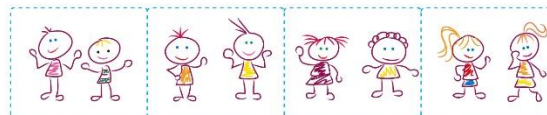

10 shared into 2 equal groups gives 5 in each group.

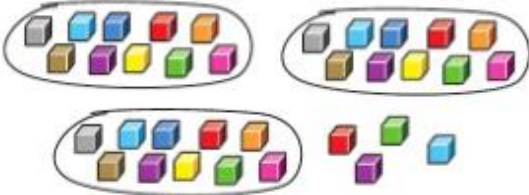
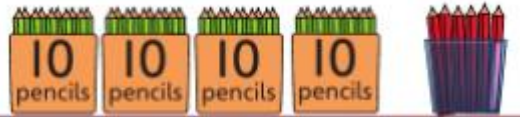
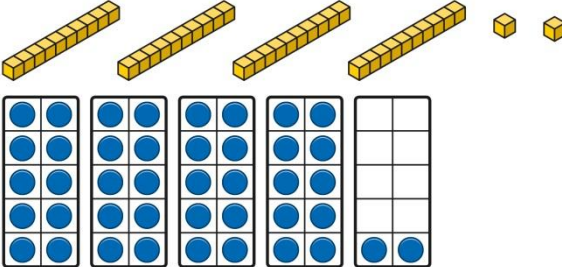
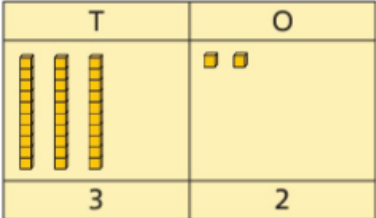
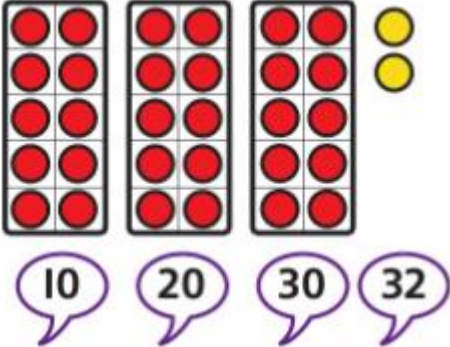
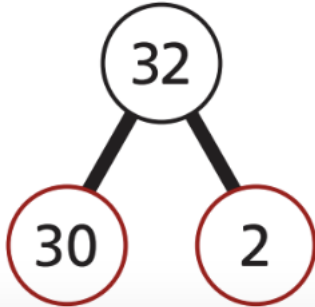
	Concrete	Pictorial	Abstract
Year 2 Addition			
Understanding 10s and 1s	<p>Group objects into 10s and 1s.</p>  <p>Bundle straws, pencils or pens to understand unitising of 10s.</p> 	<p>Understand 10s and 1s equipment, and link with visual representations on ten frames.</p>  <p>Represent numbers on a place value grid, using equipment or numerals.</p> 	<p>Partition 2-digit numbers into 10s and 1s</p>   <p>$32 = 30 + 2$</p>
Learn bonds within 10	<p>Systematically build confidence and fluency in recall of number bonds within 10</p>	<p>Systematically build confidence and fluency in recall of number bonds within 10</p>	<p>Systematically build confidence and fluency in recall of number bonds within 10</p>

Double 4

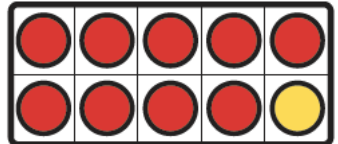
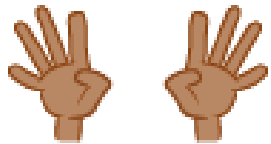

$4 + 4 = 8$. This is a double

This is a bond to 10. $9 + 1 = 10$

+	0	1	2	3	4	5	6	7	8	9	10
0	0+0	0+1	0+2	0+3	0+4	0+5	0+6	0+7	0+8	0+9	0+10
1	1+0	1+1	1+2	1+3	1+4	1+5	1+6	1+7	1+8	1+9	
2	2+0	2+1	2+2	2+3	2+4	2+5	2+6	2+7	2+8		
3	3+0	3+1	3+2	3+3	3+4	3+5	3+6	3+7			
4	4+0	4+1	4+2	4+3	4+4	4+5	4+6				
5	5+0	5+1	5+2	5+3	5+4	5+5					
6	6+0	6+1	6+2	6+3	6+4						
7	7+0	7+1	7+2	7+3							
8	8+0	8+1	8+2								
9	9+0	9+1									
10	10+0										

Adding the 1s

Children represent 10s and 1s with everyday items.



Children represent calculations using ten frames to add a teen and 1s.

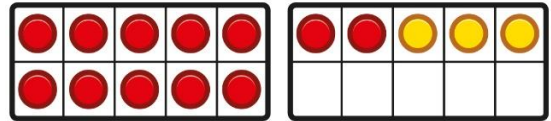

$2 + 3 = 5$
 $12 + 3 = 15$

Children recognise that a teen is made from a 10 and some 1s and use their knowledge of addition within 10 to work efficiently.

$3 + 5 = 8$
So, $13 + 5 = 18$

Bridging 10 using number bonds

Children use counters to complete a ten frame and understand how they can add using knowledge of number bonds to 10.

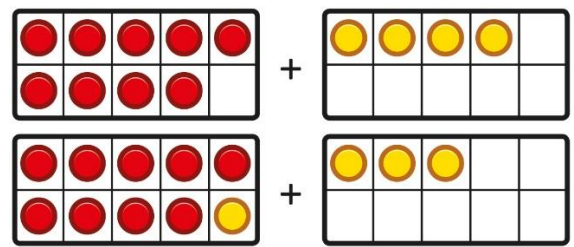

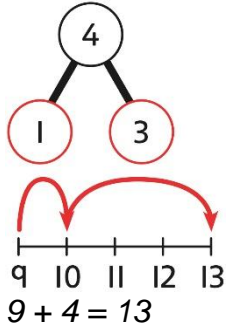

Use a part-whole model and a number line to support the calculation.



Children use a bead string to complete a 10 and understand how this relates to the addition.

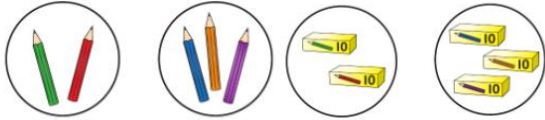
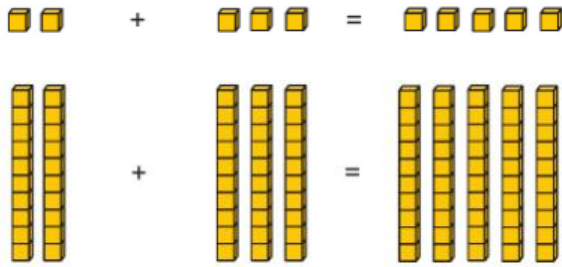
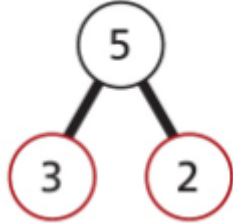

7 add 3 makes 10.
So, 7 add 5 is 10 and 2 more.

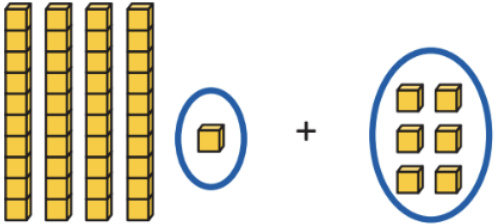
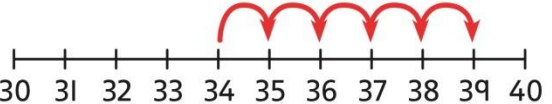
<p>Add two multiples of 10</p>	<p>Use known bonds and unitising to add 10s.</p>  <p><i>I know that $2 + 3 = 5$.</i></p> <p><i>So, I know that 2 tens add 3 tens is 5 tens.</i></p>	<p>Use known bonds and unitising to add 10s.</p>  <p><i>I know that $2 + 3 = 5$</i></p> <p><i>So, I know that 2 tens add 3 tens is 5 tens.</i></p>	<p>Use known bonds and unitising to add 10s.</p>  <p>$3 + 2 = 5$</p> <p>$3 \text{ tens} + 2 \text{ tens} = 5 \text{ tens}$</p> <p>$30 + 20 = 50$</p>
<p>Add a 2-digit number and 1s</p>	<p>Add the 1s to find the total. Use known bonds within 10.</p>  <p><i>41 is 4 tens and 1 one.</i></p> <p><i>41 add 6 ones is 4 tens and 7 ones.</i></p>	<p>Add the ones using known bonds</p>  <p>$1 + 6 = 7$</p> <p>So</p> <p>$41 + 6 = 47$</p>	<p>Add the 1s.</p> <p>Understand the link between counting on and using known number facts. Children should be encouraged to use known number bonds to improve efficiency and accuracy.</p>  <p>$4 + 5 = 9$</p> <p>So</p> <p>$34 + 5 = 39$</p>
<p>Add to the next 10</p>	<p>Use known bonds to 10 to add to the next multiple of 10</p>	<p>Use known bonds to 10 to add to the next multiple of 10</p>	<p>Use known bonds to 10 to add to the next multiple of 10</p>

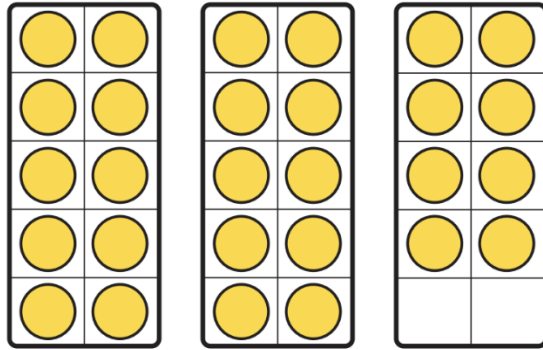

$$8 + 2 = 10$$

So

$$28 + 2 = 30$$

$$3 + \square = 10$$

$$33 + \square = 40$$

$$43 + \square = 50$$

$$73 + \square = 80$$

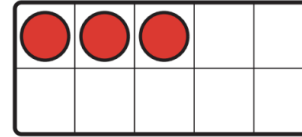

60	
55	?

$$55 + \square = 60$$

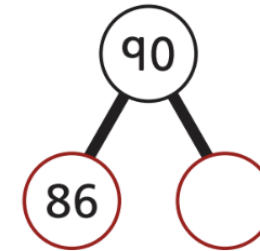

$$86 + \square = 90$$

Add across a 10

Use place value equipment to support adding across any multiple of 10

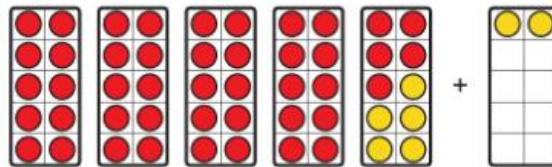

$$45 + 5 + 2 = 52$$

$$45 + 7 = 52$$

Add across any multiple of 10 using two jumps

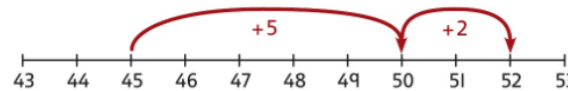

$$45 + 5 + 2 = 52$$

$$45 + 7 = 52$$

Add across any multiple of 10 using two steps

$$45 + 5 + 2 = 52$$

$$45 + 7 = 52$$

Add 10s to a 2-digit number

Add the 10s using a place value grid to support, using classroom items to represent the numbers.

Add the 10s using a place value grid to support.

Use known bonds and knowledge of place value to add multiples of 10

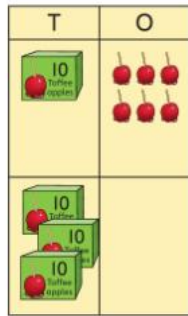

16 is 1 ten and 6 ones.
30 is 3 tens.
There are 4 tens and 6 ones in total.

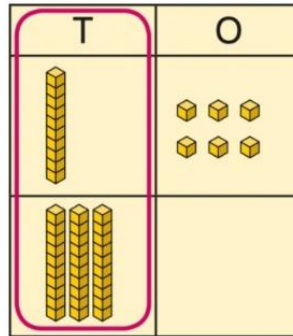

16 is 1 ten and 6 ones.
30 is 3 tens.
There are 4 tens and 6 ones in total.

$$16 + 30 = ?$$

1 ten + 3 tens is 4 tens

There are 4 tens and 6 ones in total.

$$16 + 30 = 46$$

Count on in tens from a given number

'Start on 16', '26', '36', '46'

$$16 + 30 = 46$$

Add more 10s then more 1s

Add on from a 2-digit number by adding tens then ones.

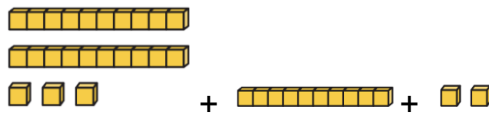

Start on "23", "33", "35"

Add on from a 2-digit number by adding 10s then 1s.

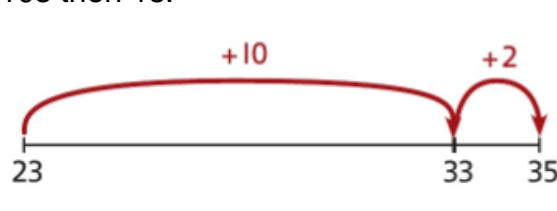

$$23 + 12 = 23 + 10 + 2$$

Add on from a 2-digit number by adding tens then ones.

$$23 + 12 = 23 + 10 + 2$$

Add the 1s and 10s separately

Add the 10s and 1s separately.

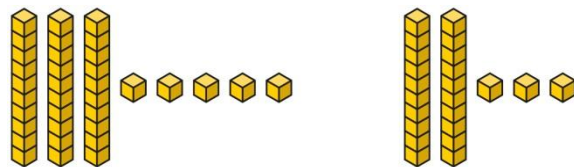

$$5 + 3 = 8$$

Add the 1s and the 10s then recombine

Add the 10s and 1s separately.

$$32 + 11$$

$$30 + 10 = 40$$

$$2 + 1 = 3$$

$$32 + 11 = 43$$

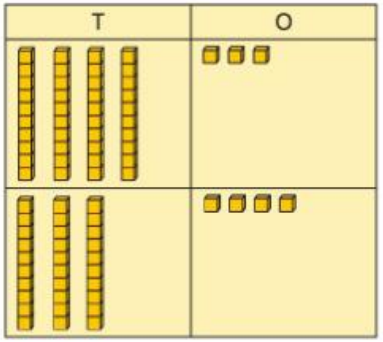
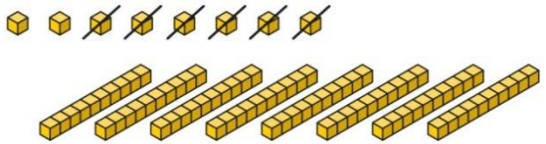
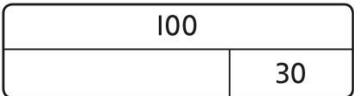
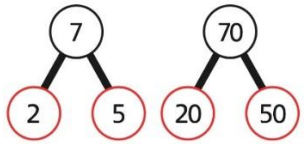
	<p><i>There are 8 ones in total.</i></p> $3 + 2 = 5$ <p><i>There are 5 tens in total.</i></p> $35 + 23 = 58$	 <p>3 ones and 4 ones is 7 ones</p> <p>4 tens and 3 tens is 7 tens</p> $43 + 34 = 77$	
Year 2 Subtraction			
Subtract two multiples of 10	<p>Use known number bonds and unitising to subtract multiples of 10.</p>  <p><i>8 subtract 6 is 2.</i> <i>So, 8 tens subtract 6 tens is 2 tens.</i></p>	<p>Use known number bonds and unitising to subtract multiples of 10.</p>  <p>$10 - 3 = 7$ <i>So, 10 tens subtract 3 tens is 7 tens.</i></p>	<p>Use known number bonds and unitising to subtract multiples of 10.</p>  <p><i>7 tens subtract 5 tens is 2 tens.</i> $70 - 50 = 20$</p>
Subtraction within 20	<p>Subtraction within 20 Understand when and how to subtract 1s efficiently.</p>	<p>Subtraction within 20 Understand how to use knowledge of bonds within 10 to subtract efficiently.</p> $5 - 3 = 2$ $15 - 3 = 12$	<p>Subtraction within 20 Understand when and how to subtract 1s efficiently.</p> <p>Use a bead string to subtract 1s efficiently.</p>

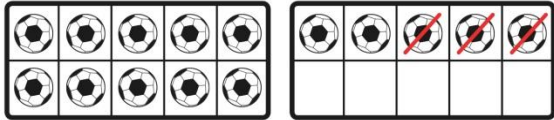

$$5 - 3 = 2$$

$$15 - 3 = 12$$



$$5 - 3 = 2$$

$$15 - 3 = 12$$

Subtracting 10s and 1s

Subtracting 10s and 1s

For example: $18 - 12$

Use ten frames to represent the efficient method of subtracting 12.

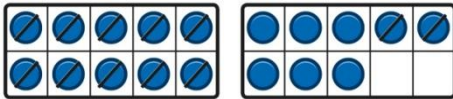

First subtract the 10, then subtract 2.

Subtracting 10s and 1s

Use a part-whole model to support the calculation.

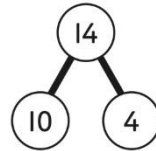

$$19 - 14$$

$$19 - 10 = 9$$

$$9 - 4 = 5$$

So, $19 - 14 = 5$

Subtracting 10s and 1s

For example: $18 - 12$

First subtract the 10, then take away 2.

Subtraction bridging 10 using number bonds

Subtraction bridging 10 using number bonds

Represent the use of bonds using ten frames.

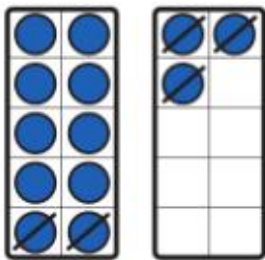

For $13 - 5$, I take away 3 to make 10, then take away 2 to make 8.

Subtraction bridging 10 using number bonds

Use a number line and a part-whole model to support the method.

$$13 - 5$$

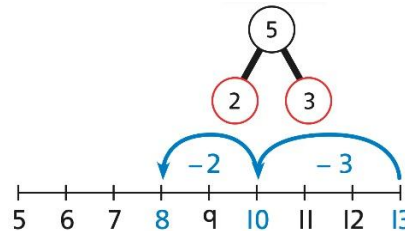





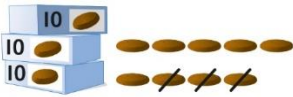

Subtraction bridging 10 using number bonds

For example: $12 - 7$

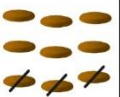
Arrange objects into a 10 and some 1s, then decide on how to split the 7 into parts.

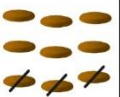
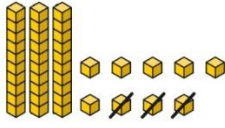
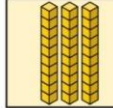
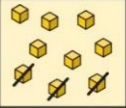
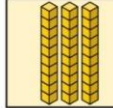
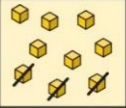
7 is 2 and 5, so I take away the 2 and then the 5.

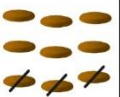
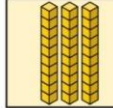
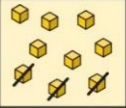
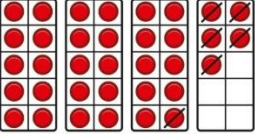
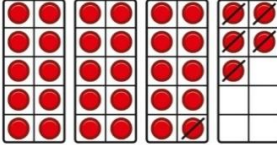
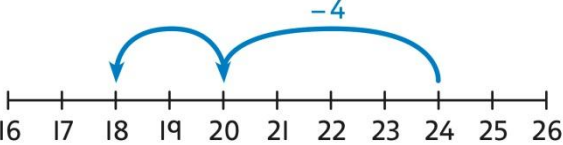
<p>Subtracting a single-digit number</p>	<p>Subtract the 1s. This may be done in or out of a place value grid using classroom items to represent the numbers.</p>  <table border="1" data-bbox="360 443 607 592"> <thead> <tr> <th>T</th> <th>O</th> </tr> </thead> <tbody> <tr> <td></td> <td></td> </tr> </tbody> </table> <p>“9 ones subtract 3 ones is 6 ones”</p> $39 - 3 = 36$	T	O			<p>Subtract the 1s. This may be done in or out of a place value grid.</p>  <table border="1" data-bbox="958 400 1218 555"> <thead> <tr> <th>T</th> <th>O</th> </tr> </thead> <tbody> <tr> <td></td> <td></td> </tr> </tbody> </table> <p>“9 ones subtract 3 ones is 6 ones”</p> $39 - 3 = 36$	T	O			<p>Subtract the 1s. Understand the link between counting back and subtracting the 1s using known bonds.</p>  $9 - 3 = 6$ $39 - 3 = 36$
T	O										
											
T	O										
											
<p>Subtracting a single-digit number bridging 10</p>	<p>Bridge 10 by using known bonds.</p>  $35 - 6$ <p><i>I took away 5 counters, then 1 more.</i></p>	<p>Bridge 10 by using known bonds.</p>  $35 - 6$ <p><i>First, I will subtract 5, then 1.</i></p>	<p>Bridge 10 by using known bonds.</p>  $24 - 6 = ?$ $24 - 4 - 2 = ?$								
<p>Subtract tens from a 2-digit number</p>		<p>Subtract tens using known bonds</p>	<p>Subtract tens using known bonds</p> $43 - 10 = 33$								

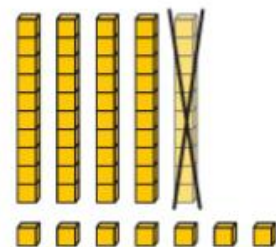

$$57 - 10 = 47$$

Subtract ones from a 2-digit number

Subtract the 1s. This may be done in or out of a place value grid.

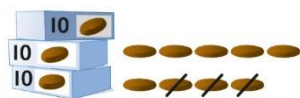

T	O

9 ones subtract 3 ones is 6 ones.

$$39 - 3 = 36$$

Subtract the 1s. This may be done in or out of a place value grid.

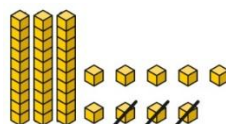

T	O

9 ones subtract 3 ones is 6 ones.

$$39 - 3 = 36$$

Subtract the 1s. Understand the link between counting back and subtracting the 1s using known bonds.

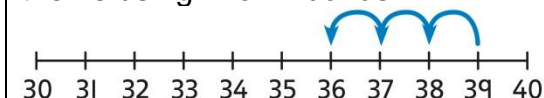

$$9 - 3 = 6$$

$$39 - 3 = 36$$

Subtract tens and ones from a 2-digit number

Subtract 10s then 1s using place value equipment.

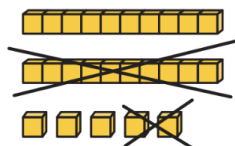

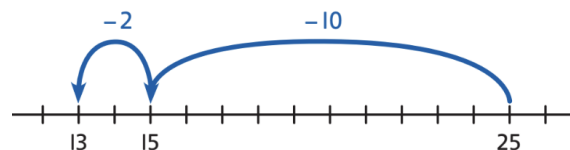

Subtract 10s then 1s with a number line for visual support.



Subtract 10s then 1s.

$$25 - 10 - 2 = 13$$

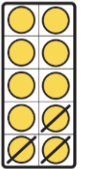
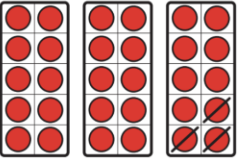
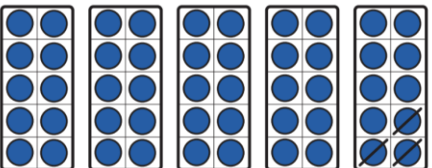
$$25 - 12 = 13$$

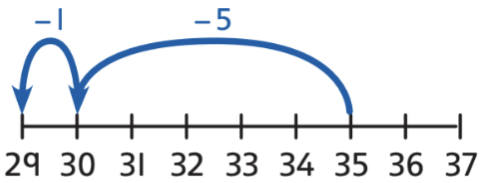
	$25 - 10 - 2 = 13$ $25 - 12 = 13$	$25 - 10 - 2 = 13$ $25 - 12 = 13$	
Subtract ones from a multiple of 10 (preparation for bridging)	<p>Subtract from a 10 using known bonds to 10 using place value equipment.</p>  $10 - 3 = 7$  $30 - 3 = 27$  $50 - 3 = 47$	<p>Subtract from a 10 using known bonds to 10.</p>  $50 - 2 = 48$	<p>Subtract from a 10 using known bonds to 10.</p> $10 - 3 = 7$ $30 - 3 = 27$ $60 - 3 = 57$ $90 - 3 = 87$
Subtract bridging a ten	<p>Subtract in two steps, across a 10 with place value equipment.</p>	<p>Subtract in two steps, across a 10 with a number line for visual support.</p>  $35 - 5 - 1 = 29$	<p>Subtract in two steps, across a 10.</p> $41 - 6 = 41 - 1 - 5$ $41 - 6 = 35$

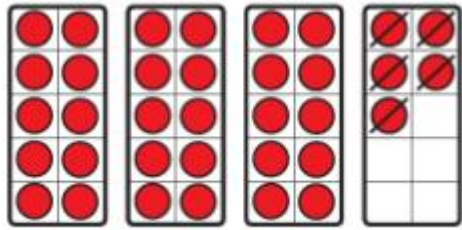

$$35 - 5 = 30$$

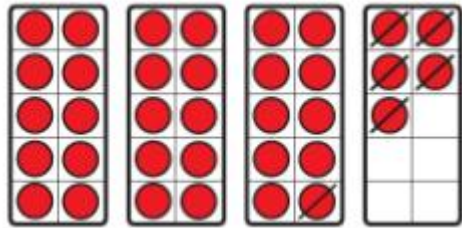

**Year 2
Multiplication**

Equal groups and repeated addition

Recognise equal groups and write as repeated addition and as multiplication.



*3 groups of 5 chairs
15 chairs altogether*

Recognise equal groups using standard objects such as counters and write as repeated addition and multiplication.



*3 groups of 5
15 in total*

Use a number line and write as repeated addition and as multiplication.

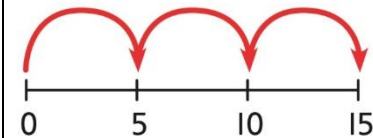

$$5 + 5 + 5 = 15$$





$$3 \times 5 = 15$$

Using arrays to represent multiplication and support

Understand the relationship between arrays, multiplication and repeated addition.

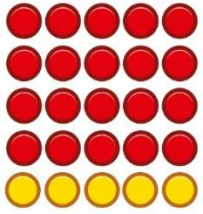
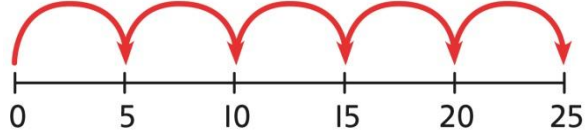
Understand the relationship between arrays, multiplication and repeated addition.

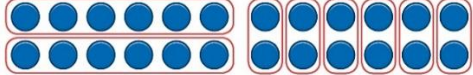
Understand the relationship between arrays, multiplication and repeated addition.

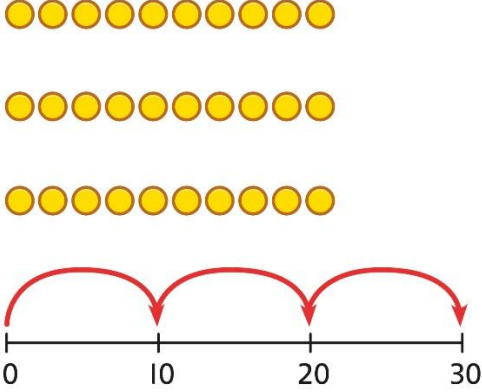
<p>understanding</p>	 <p>4 groups of 5</p>	 <p>4 groups of 5 ... 5 groups of 5</p>	 <p>$5 \times 5 = 25$</p>
<p>Understanding commutativity</p>	<p>Use arrays to visualise commutativity.</p>  <p>I can see 6 groups of 3. I can see 3 groups of 6.</p>	<p>Form arrays using counters to visualise commutativity. Rotate the array to show that orientation does not change the multiplication.</p>  <p>This is 2 groups of 6 and also 6 groups of 2.</p>	<p>Use arrays to visualise commutativity.</p>  <p>$4 + 4 + 4 + 4 + 4 = 20$ $5 + 5 + 5 + 5 = 20$ $4 \times 5 = 20$ and $5 \times 4 = 20$</p>
<p>Learning $\times 2$, $\times 5$ and $\times 10$ table facts</p>	<p>Develop an understanding of how to unitise groups of 2, 5 and 10 and learn corresponding times-table facts.</p>	<p>Understand how to relate counting in unitised groups and repeated addition with knowing key times-table facts.</p> 	<p>Understand how the times-tables increase and contain patterns.</p>





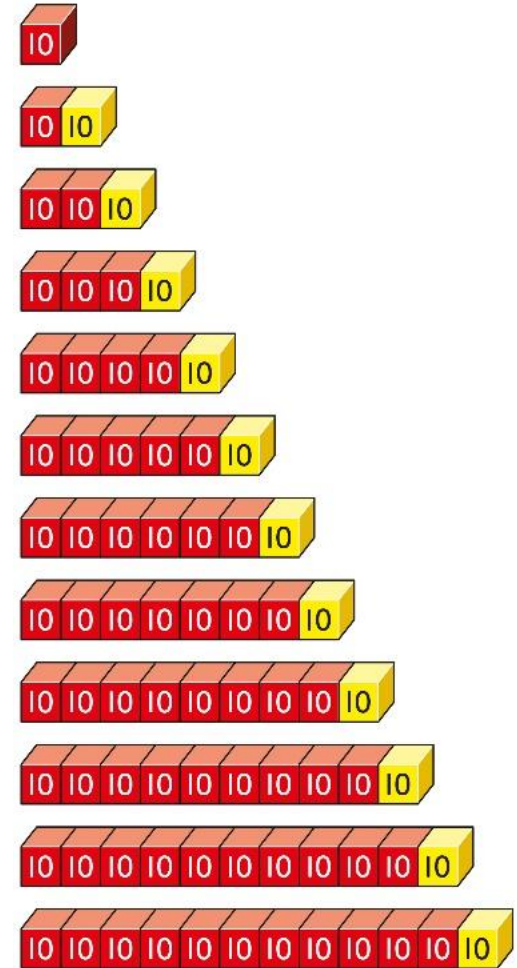

3 groups of 10 ... 10, 20, 30
 $3 \times 10 = 30$

$$10 + 10 + 10 = 30$$
$$3 \times 10 = 30$$

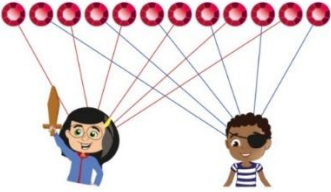

$$5 \times 10 = 50$$
$$6 \times 10 = 60$$

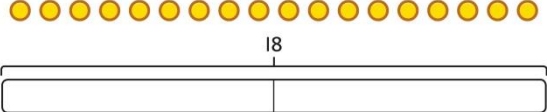
Division			
<p>Sharing equally</p>	<p>Start with a whole and share into equal parts, one at a time.</p>  <p><i>12 shared equally between 2. They get 6 each.</i></p> <p>Start to understand how this also relates to grouping. To share equally between 3 people, take a group of 3 and give 1 to each person. Keep going until all the objects have been shared</p>   <p>They get 5  each.</p> <p><i>15 shared equally between 3. They get 5 each.</i></p>	<p>Represent the objects shared into equal parts using a bar model.</p>  <p><i>20 shared into 5 equal parts. There are 4 in each part.</i></p>	<p>Use a bar model to support understanding of the division.</p>  <p>$18 \div 2 = 9$</p>
<p>Grouping equally</p>	<p>Understand how to make equal groups from a whole.</p>	<p>Understand the relationship between grouping and the division statements.</p>	<p>Understand how to relate division by grouping to repeated subtraction.</p>



8 divided into 4 equal groups.
There are 2 in each group.

$$12 \div 3 = 4$$



$$12 \div 4 = 3$$



$$12 \div 6 = 2$$



$$12 \div 2 = 6$$

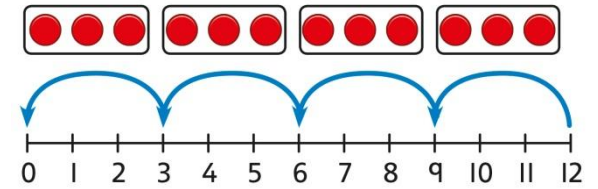

There are 4 groups now.

12 divided into groups of 3.
 $12 \div 3 = 4$

There are 4 groups.

Using known times-tables to solve divisions

Understand the relationship between multiplication facts and division.

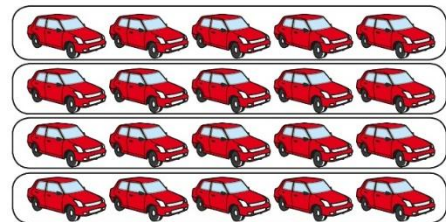

4 groups of 5 cars is 20 cars in total.
20 divided by 4 is 5.

Link equal grouping with repeated subtraction and known times-table facts to support division.

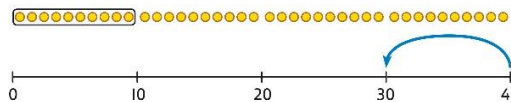

40 divided by 4 is 10.

Use a bar model to support understanding of the link between times-table knowledge and division.

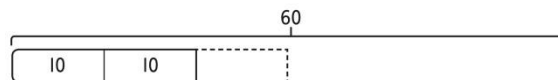

Relate times-table knowledge directly to division.

- $1 \times 10 = 10$
- $2 \times 10 = 20$
- $3 \times 10 = 30$**
- $4 \times 10 = 40$
- $5 \times 10 = 50$
- $6 \times 10 = 60$
- $7 \times 10 = 70$
- $8 \times 10 = 80$

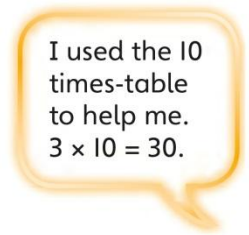

I know that 3 groups of 10 makes 30, so I know that 30 divided by 10 is 3.

$$3 \times 10 = 30 \quad \text{so} \quad 30 \div 10 = 3$$

Power Maths White Rose Edition calculation policy, LOWER KS2

KEY STAGE 2

In Years 3 and 4, children develop the basis of written methods by building their skills alongside a deep understanding of place value. They should use known addition/subtraction and multiplication/division facts to calculate efficiently and accurately, rather than relying on counting. Children use place value equipment to support their understanding, but not as a substitute for thinking.

Key language: partition, place value, tens, hundreds, thousands, column method, whole, part, equal groups, sharing, grouping, bar model

Addition and subtraction: In Year 3 especially, the column methods are built up gradually. Children will develop their understanding of how each stage of the calculation, including any exchanges, relates to place value. The example calculations chosen to introduce the stages of each method may often be more suited to a mental method. However, the examples and the progression of the steps have been chosen to help children develop their fluency in the process, alongside a deep understanding of the concepts and the numbers involved, so that they can apply these skills accurately and efficiently to later calculations. The class should be encouraged to compare mental and written methods for specific calculations, and children should be encouraged at every stage to make choices about which methods to apply.

In Year 4, the steps are shown without such fine detail, although children should continue to build their understanding with a secure basis in place value. In subtraction, children will need to develop their understanding of exchange as they may need to exchange across one or two columns.

By the end of Year 4, children should have developed fluency in column methods alongside a deep understanding, which will allow them to progress confidently in upper Key Stage 2.

Multiplication and division: Children build a solid grounding in times-tables, understanding the multiplication and division facts in tandem. As such, they should be as confident knowing that 35 divided by 7 is 5 as knowing that 5 times 7 is 35.

Children develop key skills to support multiplication methods: unitising, commutativity, and how to use partitioning effectively.

Unitising allows children to use known facts to multiply and divide multiples of 10 and 100 efficiently. Commutativity gives children flexibility in applying known facts to calculations and problem solving. An understanding of partitioning allows children to extend their skills to multiplying and dividing 2- and 3-digit numbers by a single digit.

Children develop column methods to support multiplications in these cases.



For successful division, children will need to make choices about how to partition. For example, to divide 423 by 3, it is effective to partition 423 into 300, 120 and 3, as these can be divided by 3 using known facts.

Children will also need to understand the concept of remainder, in terms of a given calculation and in terms of the context of the problem.

Fractions: Children develop the key concept of equivalent fractions, and link this with multiplying and dividing the numerators and denominators, as well as exploring the visual concept through fractions of shapes. Children learn how to find a fraction of an amount and develop this with the aid of a bar model and other representations alongside.

In Year 3, children develop an understanding of how to add and subtract fractions with the same denominator and find complements to the whole. This is developed alongside an understanding of fractions as numbers, including fractions greater than 1. In Year 4, children begin to work with fractions greater than 1.

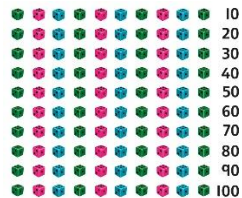
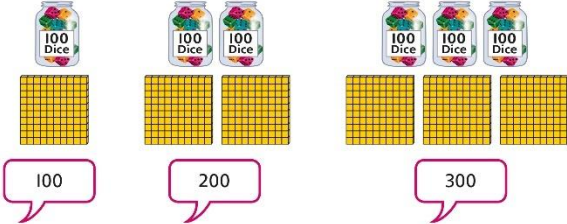
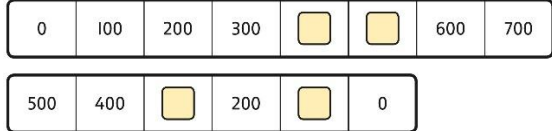
Decimals are introduced, as tenths in Year 3 and then as hundredths in Year 4. Children develop an understanding of decimals in terms of the relationship with fractions, with dividing by 10 and 100, and also with place value.

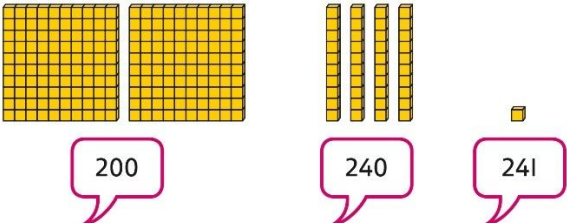
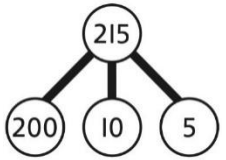
	Concrete	Pictorial	Abstract
Year 3 Addition			
Understanding 100s	<p>Understand the cardinality of 100, and the link with 10 tens.</p> <p>Use cubes to place into groups of 10 tens.</p> 	<p>Unitise 100 and count in steps of 100.</p> 	<p>Represent steps of 100 on a number line and a number track and count up to 1,000 and back to 0.</p> 
Understanding place value to 1,000	<p>Unitise 100s, 10s and 1s to build 3-digit numbers.</p> 	<p>Use equipment to represent numbers to 1,000.</p>  <p>Use a place value grid to support the structure of numbers to 1,000.</p> <p>Place value counters are used alongside other equipment. Children should understand how each counter represents a different unitised amount.</p>	<p>Represent the parts of numbers to 1,000 using a part-whole model.</p>  <p>$215 = 200 + 10 + 5$</p> <p>Recognise numbers to 1,000 represented on a number line, including those between intervals.</p>

Adding 100s

Use known facts and unitising to add multiples of 100.

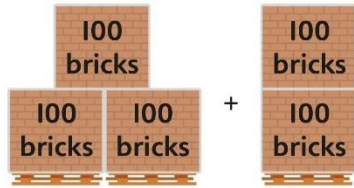

$$3 + 2 = 5$$

3 hundreds + 2 hundreds = 5 hundreds

$$300 + 200 = 500$$

Use known facts and unitising to add multiples of 100.

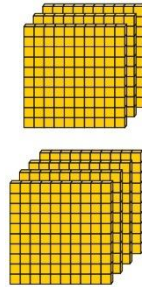

$$3 + 4 = 7$$

3 hundreds + 4 hundreds = 7 hundreds

$$300 + 400 = 700$$

Use known facts and unitising to add multiples of 100.

Represent the addition on a number line.

Use a part-whole model to support unitising.

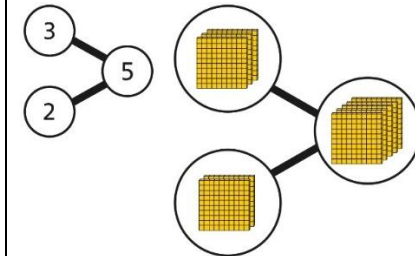

$$3 + 2 = 5$$

$$300 + 200 = 500$$

3-digit number + 1s, no exchange or bridging

Use number bonds to add the 1s.



$$214 + 4 = ?$$

Now there are 4 + 4 ones in total.

$$4 + 4 = 8$$

$$214 + 4 = 218$$

Use number bonds to add the 1s.

H	T	O
2	4	9

$$245 + 4$$

$$5 + 4 = 9$$

$$245 + 4 = 249$$

Understand the link with counting on.

$$245 + 4$$

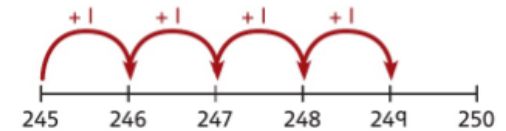

Use number bonds to add the 1s and understand that this is more efficient and less prone to error.

$$245 + 4 = ?$$

I will add the 1s.

$$5 + 4 = 9$$

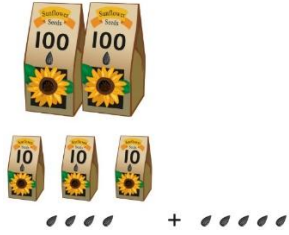
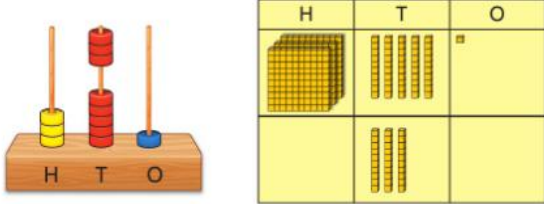
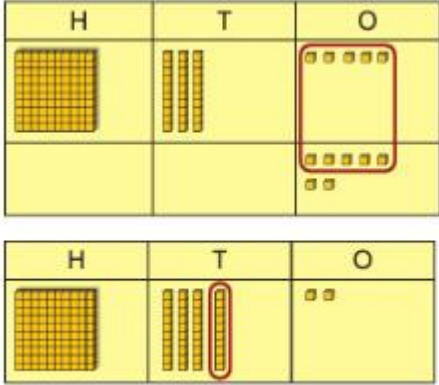
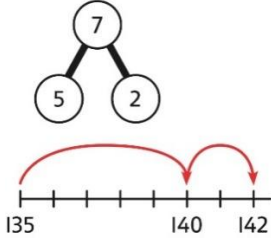
<p>3-digit number + 10s, no exchange</p>	<p>Calculate mentally by forming the number bond for the 10s.</p>  <p>$234 + 50$ <i>There are 3 tens and 5 tens altogether.</i> $3 + 5 = 8$ <i>In total there are 8 tens.</i> $234 + 50 = 284$</p>	<p>Calculate mentally by forming the number bond for the 10s.</p> <p>$351 + 30 = ?$</p>  <p>$5 \text{ tens} + 3 \text{ tens} = 8 \text{ tens}$ $351 + 30 = 381$</p>	<p>So, $245 + 4 = 249$</p> <p>Calculate mentally by forming the number bond for the 10s.</p> <p>$753 + 40$</p> <p><i>I know that $5 + 4 = 9$</i></p> <p>So, $50 + 40 = 90$ $753 + 40 = 793$</p>
<p>3-digit number + 1s with exchange</p>	<p>Understand that when the 1s sum to 10 or more, this requires an exchange of 10 ones for 1 ten.</p> <p>Children should explore this using unitted objects or physical apparatus.</p>	<p>Exchange 10 ones for 1 ten where needed. Use a place value grid to support the understanding.</p>  <p>$135 + 7 = 142$</p>	<p>Understand how to bridge by partitioning to the 1s to make the next 10.</p>  <p>$135 + 7 = ?$ $135 + 5 + 2 = 142$</p> <p>Ensure that children understand how to add 1s bridging a 100.</p> <p>$198 + 5 = ?$</p>

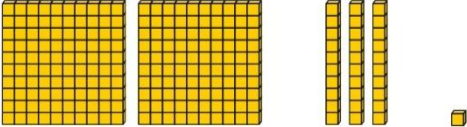
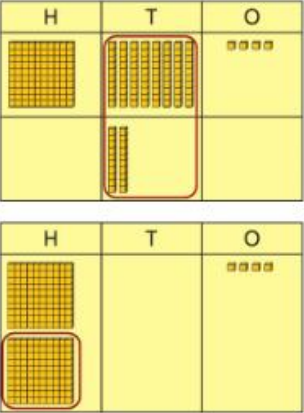
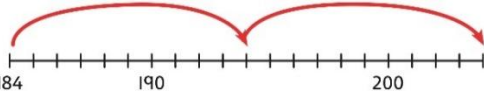
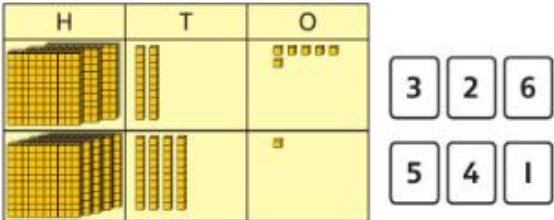
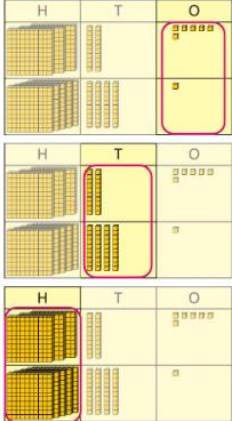
<p>3-digit number + 10s, with exchange</p>	<p>Understand the exchange of 10 tens for 1 hundred.</p> 	<p>Add by exchanging 10 tens for 1 hundred.</p> <p>$184 + 20 = ?$</p>  <p>$184 + 20 = 204$</p>	<p>$198 + 2 + 3 = 203$</p> <p>Understand how the addition relates to counting on in 10s across 100.</p>  <p>$184 + 20 = ?$</p> <p><i>I can count in 10s ... 194 ... 204</i></p> <p>$184 + 20 = 204$</p> <p>Use number bonds within 20 to support efficient mental calculations.</p> <p>$385 + 50$</p> <p><i>There are 8 tens and 5 tens. That is 13 tens.</i></p> <p>$385 + 50 = 300 + 130 + 5$</p> <p>$385 + 50 = 435$</p>
<p>3-digit number + 3-digit number, no exchange</p>	<p>Use place value equipment to make a representation of a calculation. This may or may not be structured in a place value grid.</p> <p>$326 + 541$ is represented as:</p> 	<p>Represent the place value grid with equipment to model the stages of column addition.</p> 	<p>Use a column method to solve efficiently, using known bonds. Children must understand how this relates to place value at every stage of the calculation.</p>

			<table border="1"> <tr><td></td><td>H</td><td>T</td><td>O</td></tr> <tr><td></td><td>3</td><td>2</td><td>6</td></tr> <tr><td>+</td><td>5</td><td>4</td><td>1</td></tr> <tr><td></td><td></td><td></td><td>7</td></tr> </table> <table border="1"> <tr><td></td><td>H</td><td>T</td><td>O</td></tr> <tr><td></td><td>3</td><td>2</td><td>6</td></tr> <tr><td>+</td><td>5</td><td>4</td><td>1</td></tr> <tr><td></td><td></td><td>6</td><td>7</td></tr> </table> <table border="1"> <tr><td></td><td>H</td><td>T</td><td>O</td></tr> <tr><td></td><td>3</td><td>2</td><td>6</td></tr> <tr><td>+</td><td>5</td><td>4</td><td>1</td></tr> <tr><td></td><td>8</td><td>6</td><td>7</td></tr> </table>		H	T	O		3	2	6	+	5	4	1				7		H	T	O		3	2	6	+	5	4	1			6	7		H	T	O		3	2	6	+	5	4	1		8	6	7
	H	T	O																																																
	3	2	6																																																
+	5	4	1																																																
			7																																																
	H	T	O																																																
	3	2	6																																																
+	5	4	1																																																
		6	7																																																
	H	T	O																																																
	3	2	6																																																
+	5	4	1																																																
	8	6	7																																																

3-digit number + 3-digit number, exchange required

Use place value equipment to enact the exchange required.

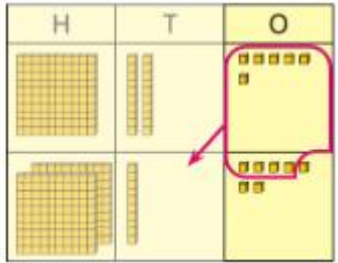

There are 13 ones.
I will exchange 10 ones for 1 ten.

Model the stages of column addition using place value equipment on a place value grid.

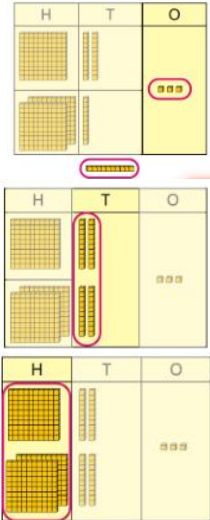



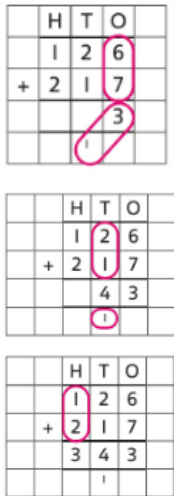



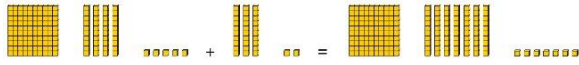
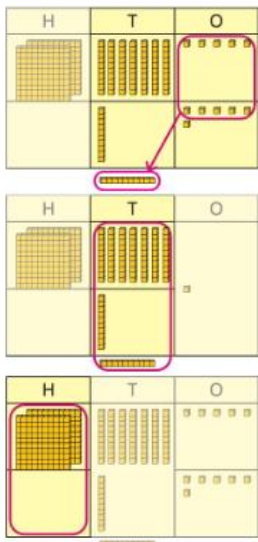
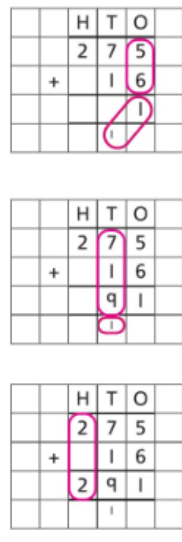

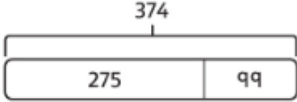
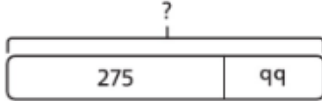
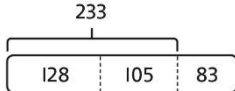
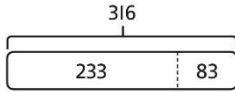
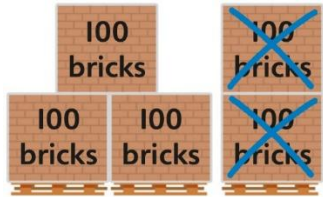
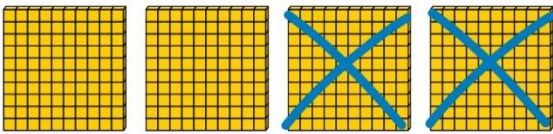
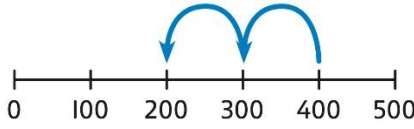











Use column addition, ensuring understanding of place value at every stage of the calculation.

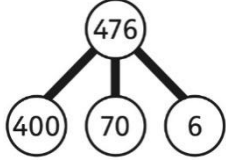

$126 + 217 = 343$
Note: Children should also study examples where exchange is required in more than one column, for example $185 + 318 = ?$

<p>3-digit number + 2-digit number</p>	<p>Use place value equipment to make and combine groups to model addition.</p> 	<p>Use a place value grid to organise thinking and adding of 1s, then 10s.</p>	<p>Use the vertical column method to represent the addition. Children must understand how this relates to place value at each stage of the calculation.</p>
<p>3-digit number + 2-digit number, exchange required</p>	<p>Use place value equipment to model addition and understand where exchange is required.</p> <p><i>Use place value counters to represent 154 + 72.</i></p> <p><i>Use this to decide if any exchange is required.</i></p> <p><i>There are 5 tens and 7 tens. That is 12 tens so 1 will exchange.</i></p>	<p>Represent the required exchange on a place value grid using equipment.</p> <p>$275 + 16 = ?$</p>  <p>$275 + 16 = 291$</p> <p><i>Note: In this example, a mental method may be more efficient. The numbers for the example calculation have been chosen to allow children to visualise the concept and see how the method relates to place value.</i></p>	<p>Use a column method with exchange. Children must understand how the method relates to place value at each stage of the calculation.</p>  <p>$275 + 16 = 291$</p>

		<p>Children should be encouraged at every stage to select methods that are accurate and efficient.</p>	
<p>Representing addition problems, and selecting appropriate methods</p>	<p>Encourage children to use their own drawings and choices of place value equipment to represent problems with one or more steps.</p> <p>These representations will help them to select appropriate methods.</p>	<p>Children understand and create bar models to represent addition problems.</p> <p>$275 + 99 = ?$</p>  <p>$275 + 99 = 374$</p>	<p>Use representations to support choices of appropriate methods.</p>  <p><i>I will add 100, then subtract 1 to find the solution.</i></p> <p>$128 + 105 + 83 = ?$</p> <p><i>I need to add three numbers.</i></p> <p>$128 + 105 = 233$</p>  
<p>Year 3 Subtraction</p>			
<p>Subtracting 100s</p>	<p>Use known facts and unitising to subtract multiples of 100.</p>  <p>$5 - 2 = 3$</p>	<p>Use known facts and unitising to subtract multiples of 100.</p>  <p>$4 - 2 = 2$</p> <p>$400 - 200 = 200$</p>	<p>Understand the link with counting back in 100s.</p>  <p>$400 - 200 = 200$</p>

	$500 - 200 = 300$		Use known facts and unitising as efficient and accurate methods. <i>I know that $7 - 4 = 3$. Therefore, I know that $700 - 400 = 300$.</i>																		
3-digit number – 1s, no exchange	Use number bonds to subtract the 1s.  $214 - 3 = ?$  $4 - 3 = 1$ $214 - 3 = 211$	Use number bonds to subtract the 1s. <table border="1" data-bbox="958 395 1265 574"> <thead> <tr> <th>H</th> <th>T</th> <th>O</th> </tr> </thead> <tbody> <tr> <td></td> <td></td> <td></td> </tr> <tr> <td>3</td> <td>1</td> <td>9</td> </tr> </tbody> </table> $319 - 4 = ?$ <table border="1" data-bbox="958 686 1265 869"> <thead> <tr> <th>H</th> <th>T</th> <th>O</th> </tr> </thead> <tbody> <tr> <td></td> <td></td> <td></td> </tr> <tr> <td>3</td> <td>1</td> <td>9</td> </tr> </tbody> </table> $9 - 4 = 5$ $319 - 4 = 315$	H	T	O				3	1	9	H	T	O				3	1	9	Understand the link with counting back using a number line. Use known number bonds to calculate mentally. $476 - 4 = ?$  $6 - 4 = 2$ $476 - 4 = 472$
H	T	O																			
																					
3	1	9																			
H	T	O																			
																					
3	1	9																			
3-digit number – 1s, exchange or bridging required	Understand why an exchange is necessary by exploring why 1 ten must be exchanged. Use place value equipment.	Represent the required exchange on a place value grid. $151 - 7 = ?$	Calculate mentally by using known bonds. $151 - 7 = ?$ $151 - 1 - 6 = 144$																		

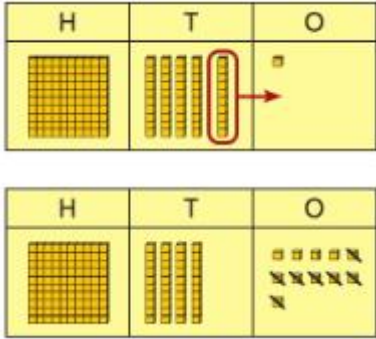
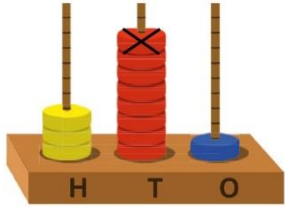
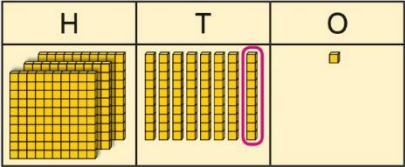
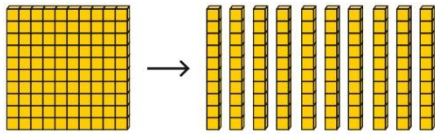
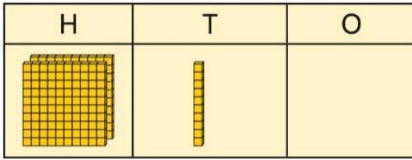
			
<p>3-digit number – 10s, no exchange</p>	<p>Subtract the 10s using known bonds.</p>  <p>$381 - 10 = ?$</p> <p><i>8 tens with 1 removed is 7 tens.</i></p> <p>$381 - 10 = 371$</p>	<p>Subtract the 10s using known bonds.</p>  <p><i>8 tens – 1 ten = 7 tens</i></p> <p>$381 - 10 = 371$</p>	<p>Use known bonds to subtract the 10s mentally.</p> <p>$372 - 50 = ?$</p> <p>$70 - 50 = 20$</p> <p>So, $372 - 50 = 322$</p>
<p>3-digit number – 10s, exchange or bridging required</p>	<p>Use equipment to understand the exchange of 1 hundred for 10 tens.</p> 	<p>Represent the exchange on a place value grid using equipment.</p> <p>$210 - 20 = ?$</p> 	<p>Understand the link with counting back on a number line.</p> <p>Use flexible partitioning to support the calculation.</p> <p>$235 - 60 = ?$</p>

I need to exchange 1 hundred for 10 tens, to help subtract 2 tens.

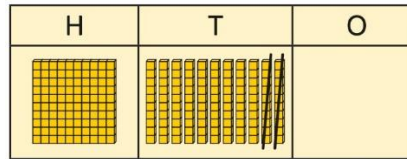

$$210 - 20 = 190$$

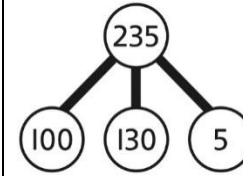

$$235 = 100 + 130 + 5$$

$$235 - 60 = 100 + 70 + 5$$

$$= 175$$

3-digit number – up to 3-digit number

Use place value equipment to explore the effect of splitting a whole into two parts, and understand the link with taking away.

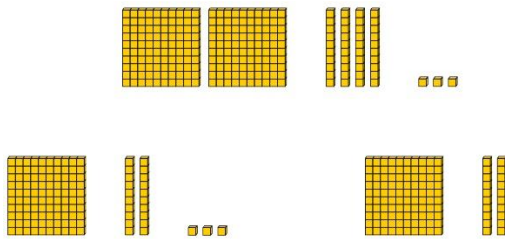

Represent the calculation on a place value grid.

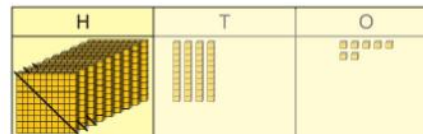
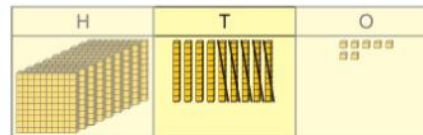
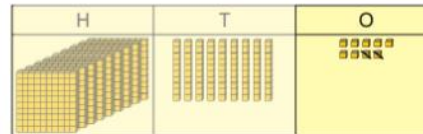

Use column subtraction to calculate accurately and efficiently.

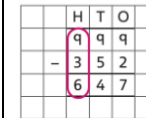
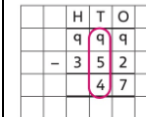
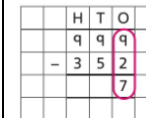

3-digit number – up to 3-digit number, exchange required

Use base 10 equipment to enact the exchange of 1 hundred for 10 tens, and 1 ten for 10 ones.

Model the required exchange on a place value grid.

$$175 - 38 = ?$$

I need to subtract 8 ones, so I will exchange a ten for 10 ones.

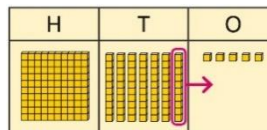

Use column subtraction to work accurately and efficiently.

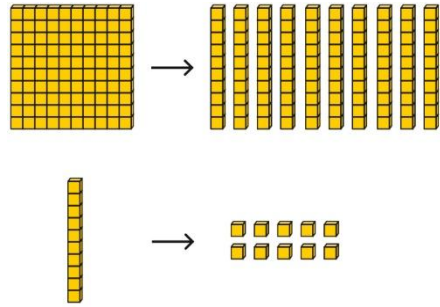

H	T	O
H	T	O

	H	T	O
	3	0	1
-	1	4	7

	H	T	O
	3	0	1
-	1	4	7
		4	

	H	T	O
	3	0	1
-	1	4	7
		1	4

	H	T	O
	3	0	1
-	1	4	7
	2	1	4

If the subtraction is a 3-digit number subtract a 2-digit number, children should understand how the recording relates to the place value, and so how to line up the digits correctly. Children should also understand how to exchange in calculations where there is a zero in the 10s column.

Representing subtraction problems

Use bar models to represent subtractions.

'Find the difference' is represented as two bars for comparison.

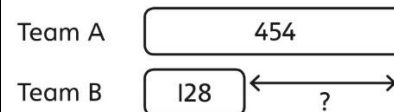

Children use alternative representations to check calculations and choose efficient methods.

Children use inverse operations to check additions and subtractions. The part-whole model supports understanding.

*I have completed this subtraction.
525 - 270 = 255
I will check using addition.*

Bar models can also be used to show that a part must be taken away from the whole.

		H	T	O	
		2	7	0	
	+	2	5	5	
		5	2	5	

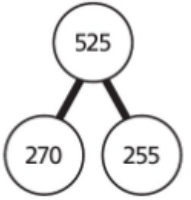

Year 3 Multiplication

Understanding equal grouping and repeated addition

Children continue to build understanding of equal groups and the relationship with repeated addition. They recognise both examples and non-examples using objects.

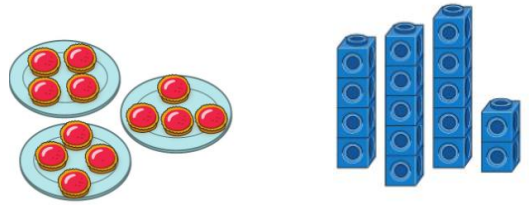

Children recognise that arrays can be used to model commutative multiplications.

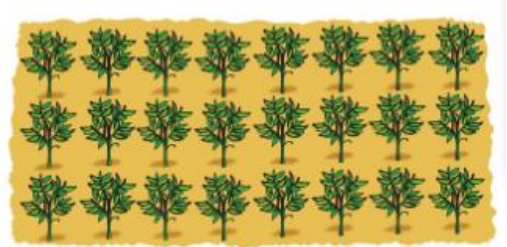

I can see 3 groups of 8.

Children recognise that arrays demonstrate commutativity.

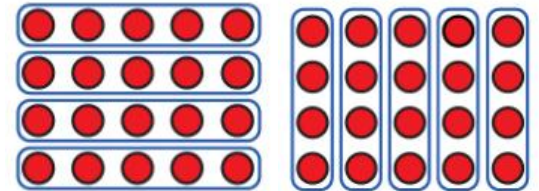

*This is 3 groups of 4.
This is 4 groups of 3.*

Children understand the link between repeated addition and multiplication.

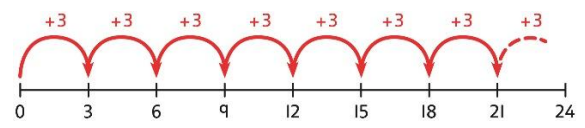



8 groups of 3 is 24.

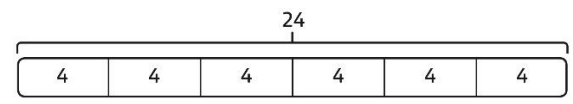

$3 + 3 + 3 + 3 + 3 + 3 + 3 + 3 = 24$
 $8 \times 3 = 24$

A bar model may represent multiplications as equal groups.

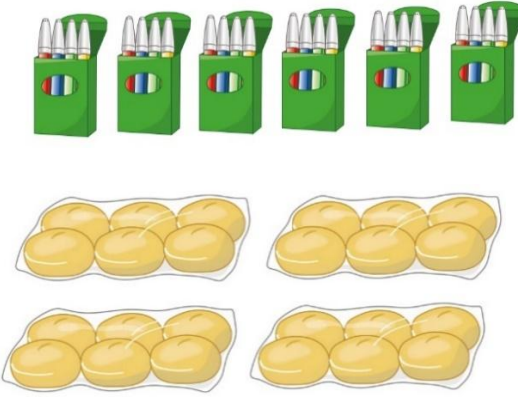
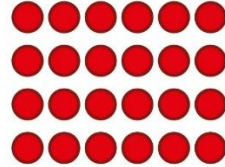

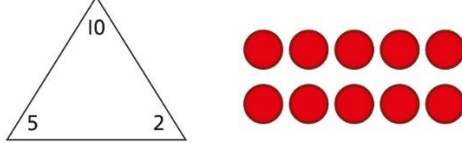
$6 \times 4 = 24$

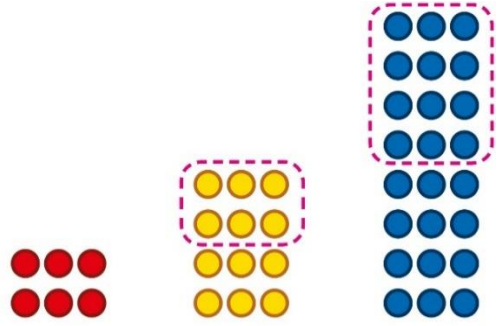
	<p><i>I can see 8 groups of 3.</i></p>		
<p>Using commutativity to support understanding of the times-tables</p>	<p>Understand how to use times-tables facts flexibly.</p>  <p><i>There are 6 groups of 4 pens. There are 4 groups of 6 bread rolls.</i></p> <p><i>I can use $6 \times 4 = 24$ to work out both totals.</i></p>	<p>Understand how times-table facts relate to commutativity.</p>  <p>$6 \times 4 = 24$ $4 \times 6 = 24$</p>	<p>Understand how times-table facts relate to commutativity.</p> <p><i>I need to work out 4 groups of 7.</i></p> <p><i>I know that $7 \times 4 = 28$</i></p> <p><i>so, I know that</i></p> <p><i>4 groups of 7 = 28</i> <i>and</i> <i>7 groups of 4 = 28.</i></p>
<p>Understanding and using $\times 3$, $\times 2$, $\times 4$ and $\times 8$ tables.</p>	<p>Children learn the times-tables as 'groups of' but apply their knowledge of commutativity.</p>  <p><i>I can use the $\times 3$ table to work out how many keys.</i></p>	<p>Children understand how the $\times 2$, $\times 4$ and $\times 8$ tables are related through repeated doubling.</p>	<p>Children understand the relationship between related multiplication and division facts in known times-tables.</p>  <p>$2 \times 5 = 10$ $5 \times 2 = 10$ $10 \div 5 = 2$ $10 \div 2 = 5$</p>

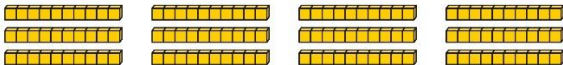
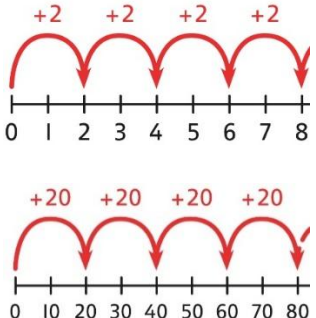
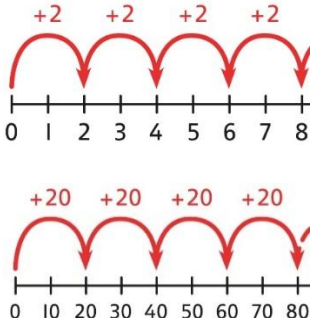
	<p><i>I can also use the $\times 3$ table to work out how many batteries.</i></p>	 <p>$3 \times 2 = 6$ $3 \times 4 = 12$ $3 \times 8 = 24$</p>	
<p>Using known facts to multiply 10s, for example 3×40</p>	<p>Explore the relationship between known times-tables and multiples of 10 using place value equipment.</p> <p><i>Make 4 groups of 3 ones.</i></p>  <p><i>Make 4 groups of 3 tens.</i></p>  <p><i>What is the same?</i> <i>What is different?</i></p>	<p>Understand how unitising 10s supports multiplying by multiples of 10.</p>  <p><i>4 groups of 2 ones is 8 ones.</i> <i>4 groups of 2 tens is 8 tens.</i></p> <p>$4 \times 2 = 8$ $4 \times 20 = 80$</p>	<p>Understand how to use known times-tables to multiply multiples of 10.</p>  <p>$4 \times 2 = 8$ $4 \times 20 = 80$</p>
<p>Multiplying a 2-digit number by a 1-digit number</p>	<p>Understand how to link partitioning a 2-digit number with multiplying.</p> <p><i>Each person has 23 flowers.</i></p>	<p>Use place value to support how partitioning is linked with multiplying by a 2-digit number.</p> <p>$3 \times 24 = ?$</p>	<p>Use addition to complete multiplications of 2-digit numbers by a 1-digit number.</p> <p>$4 \times 13 = ?$</p>











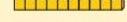

Each person has 2 tens and 3 ones.



There are 3 groups of 2 tens.









There are 3 groups of 3 ones.

Use place value equipment to model the multiplication context.

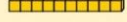







	T	O
	 	
	 	
	 	

There are 3 groups of 3 ones.

There are 3 groups of 2 tens.

T	O
 	
 	
 	

$$3 \times 4 = 12$$

T	O
 	
 	
 	

$$3 \times 20 = 60$$

$$60 + 12 = 72$$

$$3 \times 24 = 72$$

$$4 \times 3 = 12$$

$$4 \times 10 = 40$$

$$12 + 40 = 52$$

$$4 \times 13 = 52$$

Multiplying a 2-digit number by a 1-digit number, expanded column method

Use place value equipment to model how 10 ones are exchanged for a 10 in some multiplications.

$$3 \times 24 = ?$$

$$3 \times 20 = 60$$

$$3 \times 4 = 12$$

Understand that multiplications may require an exchange of 1s for 10s, and also 10s for 100s.

$$4 \times 23 = ?$$

Children may write calculations in expanded column form, but must understand the link with place value and exchange.

Children are encouraged to write the expanded parts of the calculation separately.

24 divided into groups of 8.
There are 3 groups of 8.

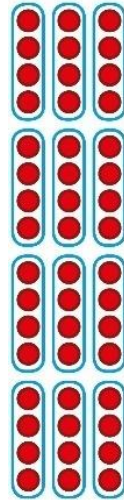

$$48 \div 4 = 12$$

48 divided into groups of 4.
There are 12 groups.

$$4 \times 12 = 48$$

$$48 \div 4 = 12$$

I know that $6 \times 5 = 30$
so I know that $30 \div 5 = 6$.

A bar model may represent the relationship between sharing and grouping.

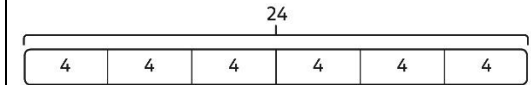

$$24 \div 4 = 6$$

$$24 \div 6 = 4$$

Children understand how division is related to both repeated subtraction and repeated addition.

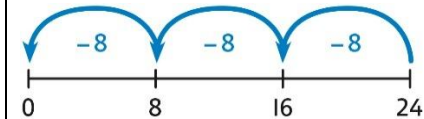

$$24 \div 8 = 3$$

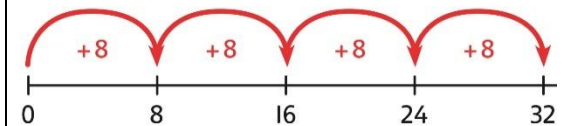

$$32 \div 8 = 4$$

Understanding remainders

Use equipment to understand that a remainder occurs when a set of objects cannot be divided equally any further.



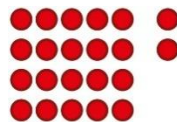

Use images to explain remainders.



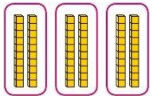
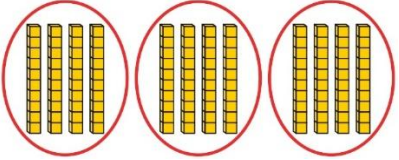
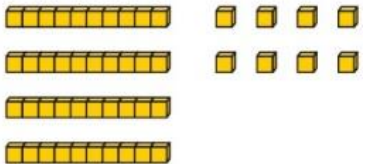
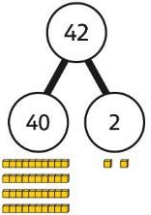
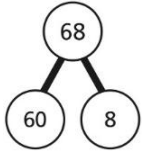

Understand that the remainder is what cannot be shared equally from a set.

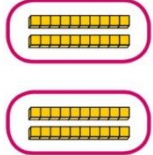
$$22 \div 5 = ?$$

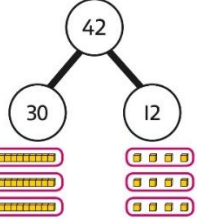









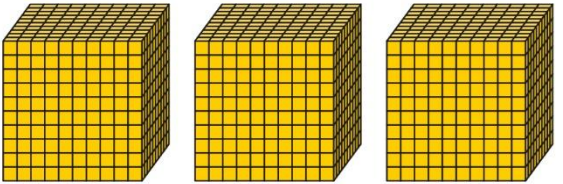

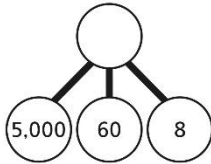
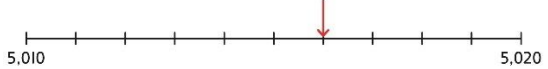







	<p>There are 13 sticks in total. There are 3 groups of 4, with 1 remainder.</p>	$22 \div 5 = 4 \text{ remainder } 2$	$3 \times 5 = 15$ $4 \times 5 = 20$ $5 \times 5 = 25 \dots \text{this is larger than } 22$ So, $22 \div 5 = 4 \text{ remainder } 2$
<p>Using known facts to divide multiples of 10</p>	<p>Use place value equipment to understand how to divide by unitising.</p> <p>Make 6 ones divided by 3.</p>  <p>Now make 6 tens divided by 3.</p>  <p>What is the same? What is different?</p>	<p>Divide multiples of 10 by unitising.</p>  <p>12 tens shared into 3 equal groups. 4 tens in each group.</p>	<p>Divide multiples of 10 by a single digit using known times-tables.</p> $180 \div 3 = ?$ 180 is 18 tens. 18 divided by 3 is 6. 18 tens divided by 3 is 6 tens. $18 \div 3 = 6$ $180 \div 3 = 60$
<p>2-digit number divided by 1-digit number, no remainders</p>	<p>Children explore dividing 2-digit numbers by using place value equipment.</p>  <p>$48 \div 2 = ?$</p> <p>First divide the 10s.</p>	<p>Children explore which partitions support particular divisions.</p>  <p>I need to partition 42 differently to divide by 3.</p>	<p>Children partition a number into 10s and 1s to divide where appropriate.</p>  <p>$60 \div 2 = 30$ $8 \div 2 = 4$</p> <p>$68 \div 2 = 34$ Children partition flexibly to divide where appropriate.</p> <p>$42 \div 3 = ?$</p>

	 <p>Then divide the 1s.</p> 	 $42 = 30 + 12$ $42 \div 3 = 14$	$42 = 40 + 2$ <p>I need to partition 42 differently to divide by 3.</p> $42 = 30 + 12$ $30 \div 3 = 10$ $12 \div 3 = 4$ $10 + 4 = 14$ $42 \div 3 = 14$
--	--	--	--

2-digit number divided by 1-digit number, with remainders	<p>Use place value equipment to understand the concept of remainder.</p> <p>Make 29 from place value equipment. Share it into 2 equal groups.</p>  <p>There are two groups of 14 and 1 remainder.</p>	<p>Use place value equipment to understand the concept of remainder in division.</p> $29 \div 2 = ?$  $29 \div 2 = 14 \text{ remainder } 1$	<p>Partition to divide, understanding the remainder in context.</p> <p>67 children try to make 5 equal lines.</p> $67 = 50 + 17$ $50 \div 5 = 10$ $17 \div 5 = 3 \text{ remainder } 2$ $67 \div 5 = 13 \text{ remainder } 2$ <p>There are 13 children in each line and 2 children left out.</p>
--	--	---	---

Year 4

	Concrete	Pictorial	Abstract
Year 4 Addition			

<p>Understanding numbers to 10,000</p>	<p>Use place value equipment to understand the place value of 4-digit numbers.</p>  <p><i>4 thousands equal 4,000.</i></p> <p><i>1 thousand is 10 hundreds.</i></p>	<p>Represent numbers using place value counters once children understand the relationship between 1,000s and 100s.</p>  <p>$2,000 + 500 + 40 + 2 = 2,542$</p>	<p>Understand partitioning of 4-digit numbers, including numbers with digits of 0.</p>  <p>$5,000 + 60 + 8 = 5,068$</p> <p>Understand and read 4-digit numbers on a number line.</p> 												
<p>Choosing mental methods where appropriate</p>	<p>Use unitising and known facts to support mental calculations.</p> <p><i>Make 1,405 from place value equipment.</i></p> <p><i>Add 2,000.</i></p> <p><i>Now add the 1,000s.</i></p> <p><i>1 thousand + 2 thousands = 3 thousands</i></p> <p>$1,405 + 2,000 = 3,405$</p>	<p>Use unitising and known facts to support mental calculations.</p> <table border="1" data-bbox="958 810 1518 975"> <thead> <tr> <th>Th</th> <th>H</th> <th>T</th> <th>O</th> </tr> </thead> <tbody> <tr> <td></td> <td></td> <td></td> <td></td> </tr> <tr> <td></td> <td></td> <td></td> <td></td> </tr> </tbody> </table> <p><i>I can add the 100s mentally.</i></p> <p>$200 + 300 = 500$</p> <p>So, $4,256 + 300 = 4,556$</p>	Th	H	T	O									<p>Use unitising and known facts to support mental calculations.</p> <p>$4,256 + 300 = ?$</p> <p>$2 + 3 = 5$ $200 + 300 = 500$</p> <p>$4,256 + 300 = 4,556$</p>
Th	H	T	O												
															
															
<p>Column addition</p>	<p>Use place value equipment on a place value grid to organise thinking.</p> <p>Ensure that children understand how the columns relate to place value and</p>	<p>Use place value equipment to model required exchanges.</p>	<p>Use a column method to add, including exchanges.</p>												

what to do if the numbers are not all 4-digit numbers.

Use equipment to show $1,905 + 775$.

Th	H	T	O
●	●●●●●●●●		●●●●●●●●
	●●●●●●●●	●●●●●●●●	●●●●●●●●

Why have only three columns been used for the second row? Why is the Thousands box empty?

Which columns will total 10 or more?

Th	H	T	O
●	●●●●●●●●	●●●●●●●●	●●●●●●●●
●●●●●●●●	●●	●●●●●●●●	●●●●●●●●

Th	H	T	O
●	●●●●●●●●	●●●●●●●●	●●●●●●●●
●●●●●●●●	●●	●●●●●●●●	●●●●●●●●

Th	H	T	O
●	●●●●●●●●	●●●●●●●●	●●●●●●●●
●●●●●●●●	●●	●●●●●●●●	●●●●●●●●

Th	H	T	O
●	●●●●●●●●	●●●●●●●●	●●●●●●●●
●●●●●●●●	●●	●●●●●●●●	●●●●●●●●

Include examples that exchange in more than one column.

Th	H	T	O
1	5	5	4
+	4	2	3
			1

Th	H	T	O
1	5	5	4
+	4	2	3
		9	1

Th	H	T	O
1	5	5	4
+	4	2	3
	7	9	1

Th	H	T	O
1	5	5	4
+	4	2	3
5	7	9	1

Include examples that exchange in more than one column.

Representing additions and checking strategies

Bar models may be used to represent additions in problem contexts, and to justify mental methods where appropriate.

1,225	
799	574

	Th	H	T	O
		7	9	9
+		5	7	4
	1	3	7	3

I chose to work out $574 + 800$, then subtract 1.

Use rounding and estimating on a number line to check the reasonableness of an addition.

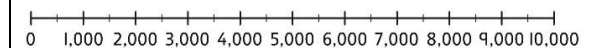

$$912 + 6,149 = ?$$

I used rounding to work out that the answer should be approximately $1,000 + 6,000 = 7,000$.

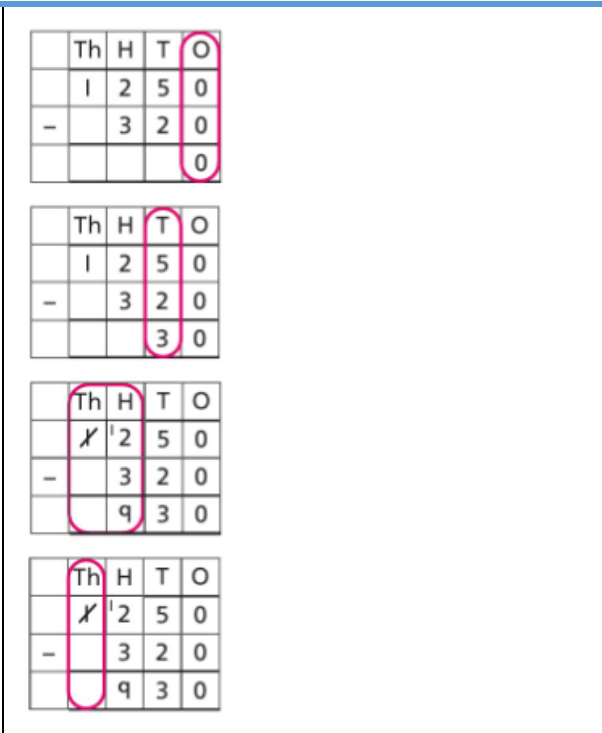
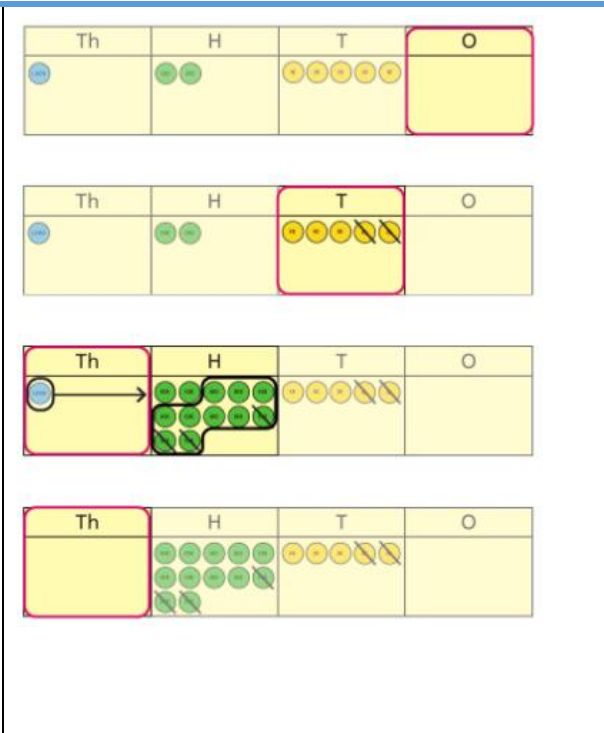
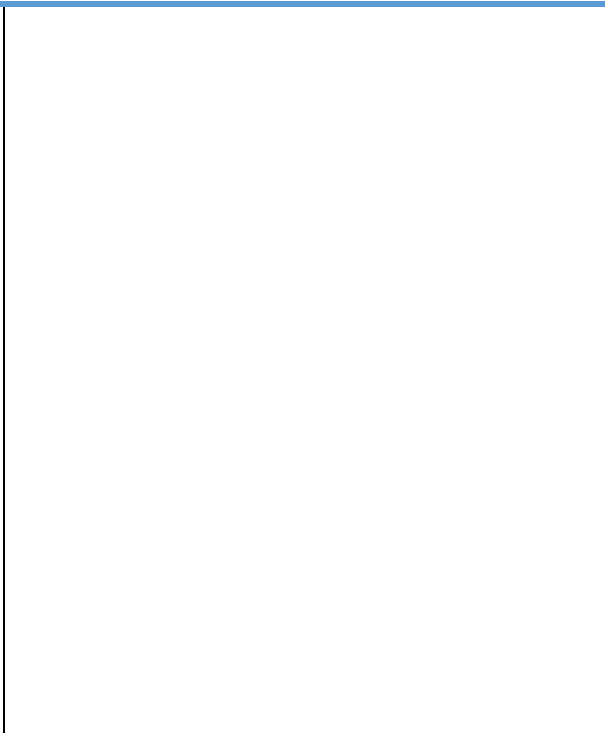
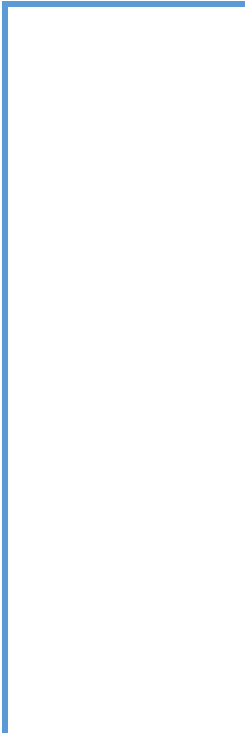

Column subtraction with exchange across more than one column

Understand why two exchanges may be necessary.

$2,502 - 243 = ?$

I need to exchange a 10 for some 1s, but there are not any 10s here.

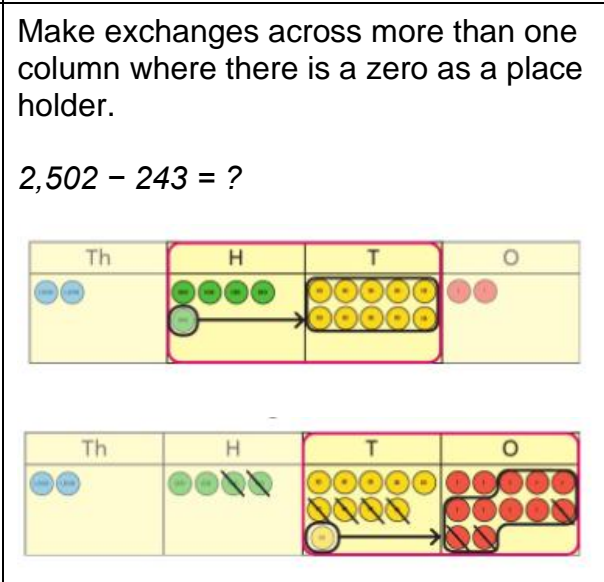

Make exchanges across more than one column where there is a zero as a place holder.

$2,502 - 243 = ?$

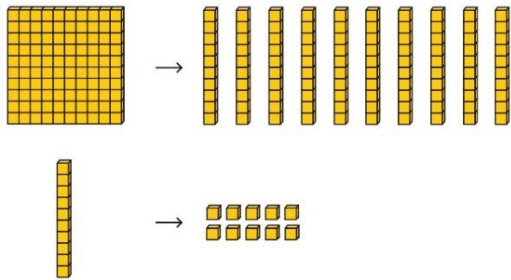

	Th	H	T	O
	2	8	0	2
-		2	4	3

	Th	H	T	O
	2	8	0	2
-		2	4	3

	Th	H	T	O
	2	8	0	2
-		2	4	3
	2	2	5	9

Representing subtractions and checking strategies

Use bar models to represent subtractions where a part needs to be calculated.

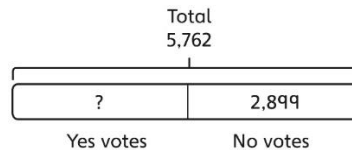

I can work out the total number of Yes votes using $5,762 - 2,899$.

Bar models can also represent 'find the difference' as a subtraction problem.

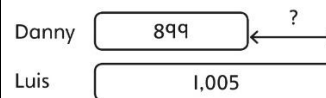

Use inverse operations to check subtractions.

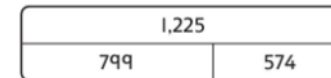

I calculated $1,225 - 799 = 574$. I will check by adding the parts.



	Th	H	T	O
		7	9	9
+		5	7	4
	1	3	7	3
	1	1	1	

The parts do not add to make 1,225. I must have made a mistake.

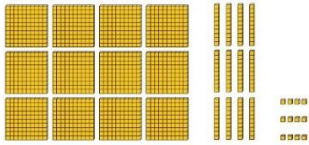
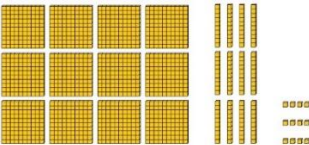
Year 4 Multiplication

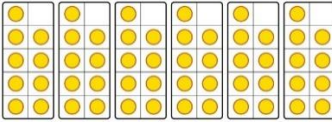
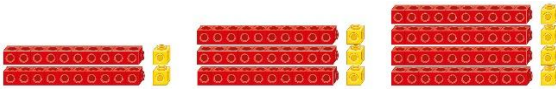
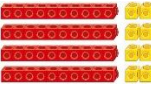
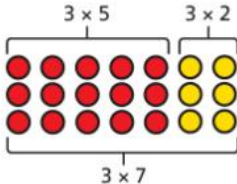
<p>Multiplying by multiples of 10 and 100</p>	<p>Use unitising and place value equipment to understand how to multiply by multiples of 1, 10 and 100.</p>  <p>3 groups of 4 ones is 12 ones. 3 groups of 4 tens is 12 tens. 3 groups of 4 hundreds is 12 hundreds.</p>	<p>Use unitising and place value equipment to understand how to multiply by multiples of 1, 10 and 100.</p>  <p>$3 \times 4 = 12$ $3 \times 40 = 120$ $3 \times 400 = 1,200$</p>	<p>Use known facts and understanding of place value and commutativity to multiply mentally.</p> <p>$4 \times 7 = 28$ $4 \times 70 = 280$ $40 \times 7 = 280$ $4 \times 700 = 2,800$ $400 \times 7 = 2,800$</p>
<p>Understanding times-tables up to 12×12</p>	<p>Understand the special cases of multiplying by 1 and 0.</p>  <p>$5 \times 1 = 5$ $5 \times 0 = 0$</p>	<p>Represent the relationship between the $\times 9$ table and the $\times 10$ table.</p>  <p>Represent the $\times 11$ table and $\times 12$ tables in relation to the $\times 10$ table.</p>  <p>$2 \times 11 = 20 + 2$ $3 \times 11 = 30 + 3$ $4 \times 11 = 40 + 4$</p>  <p>$4 \times 12 = 40 + 8$</p>	<p>Understand how times-tables relate to counting patterns.</p> <p>Understand links between the $\times 3$ table, $\times 6$ table and $\times 9$ table 5×6 is double 5×3</p> <p>$\times 5$ table and $\times 6$ table <i>I know that $7 \times 5 = 35$ so I know that $7 \times 6 = 35 + 7$.</i></p> <p>$\times 5$ table and $\times 7$ table $3 \times 7 = 3 \times 5 + 3 \times 2$</p>  <p>$\times 9$ table and $\times 10$ table $6 \times 10 = 60$ $6 \times 9 = 60 - 6$</p>
<p>Understanding and using</p>	<p>Make multiplications by partitioning.</p>	<p>Understand how multiplication and partitioning are related through addition.</p>	<p>Use partitioning to multiply 2-digit numbers by a single digit.</p>

partitioning in multiplication

4×12 is 4 groups of 10 and 4 groups of 2.

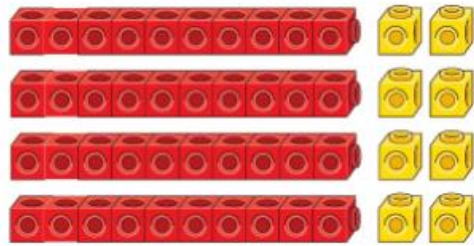

$4 \times 12 = 40 + 8$

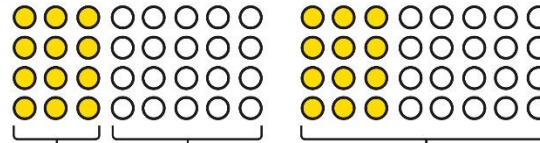

$4 \times 3 = 12$ $4 \times 9 = 36$ $4 \times 12 = 48$

$4 \times 3 = 12$
 $4 \times 9 = 36$
 $12 + 36 = 48$

$4 \times 12 = 48$

$18 \times 6 = ?$

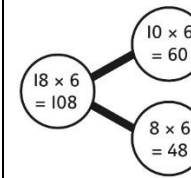

$18 \times 6 = 10 \times 6 + 8 \times 6$
 $= 60 + 48$
 $= 108$

$18 \times 6 = 10 \times 6 + 8 \times 6$
 $= 60 + 48$
 $= 108$

Column multiplication for 2- and 3-digit numbers multiplied by a single digit

Use place value equipment to make multiplications.

Make 4×136 using equipment.

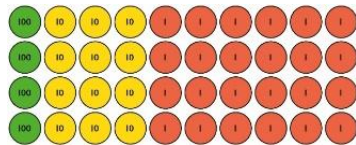

I can work out how many 1s, 10s and 100s.

There are 4×6 ones... 24 ones
 There are 4×3 tens ... 12 tens
 There are 4×1 hundreds ... 4 hundreds

$24 + 120 + 400 = 544$

Use place value equipment alongside a column method for multiplication of up to 3-digit numbers by a single digit.

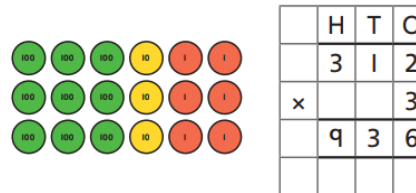



Use the formal column method for up to 3-digit numbers multiplied by a single digit.





	H	T	O
	3	1	2
x			3
	9	3	6

Understand how the expanded column method is related to the formal column method and understand how any exchanges are related to place value at each stage of the calculation.

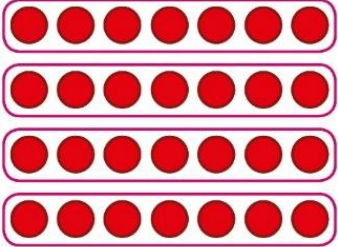
	H	T	O
		2	3
x			5
		1	5
+	1	0	0
	1	1	5

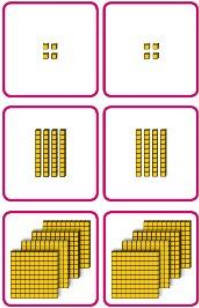
	H	T	O
		2	3
x			5
		1	5

<p>Multiplying more than two numbers</p>	<p>Represent situations by multiplying three numbers together.</p>  <p>Each sheet has 2×5 stickers. There are 3 sheets.</p> <p>There are $5 \times 2 \times 3$ stickers in total.</p> $5 \times 2 \times 3 = 30$ $\underbrace{5 \times 2}_{10} \times 3 = 30$ $10 \times 3 = 30$	<p>Understand that commutativity can be used to multiply in different orders.</p>  $2 \times 6 \times 10 = 120$ $12 \times 10 = 120$ $10 \times 6 \times 2 = 120$ $60 \times 2 = 120$	<p>Use knowledge of factors to simplify some multiplications.</p> $24 \times 5 = 12 \times 2 \times 5$ $12 \times 2 \times 5 =$ $\underbrace{12 \times 2}_{12} \times 5 = 120$ <p>So, $24 \times 5 = 120$</p>
<p>Year 4 Division</p>			
<p>Understanding the relationship between multiplication and division, including times-tables</p>	<p>Use objects to explore families of multiplication and division facts.</p>  $4 \times 6 = 24$ <p>24 is 6 groups of 4. 24 is 4 groups of 6.</p> <p>24 divided by 6 is 4. 24 divided by 4 is 6.</p>	<p>Represent divisions using an array.</p>  $28 \div 7 = 4$	<p>Understand families of related multiplication and division facts.</p> <p>I know that $5 \times 7 = 35$</p> <p>so I know all these facts:</p> $5 \times 7 = 35$ $7 \times 5 = 35$ $35 = 5 \times 7$ $35 = 7 \times 5$ $35 \div 5 = 7$ $35 \div 7 = 5$ $7 = 35 \div 5$

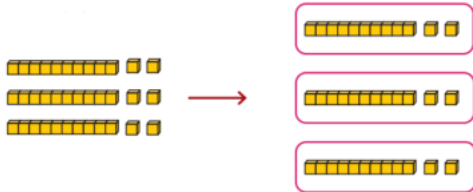
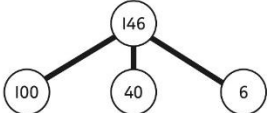
<p>Dividing multiples of 10 and 100 by a single digit</p>	<p>Use place value equipment to understand how to use unitising to divide.</p>  <p><i>8 ones divided into 2 equal groups 4 ones in each group</i></p> <p><i>8 tens divided into 2 equal groups 4 tens in each group</i></p> <p><i>8 hundreds divided into 2 equal groups 4 hundreds in each group</i></p>	<p>Represent divisions using place value equipment.</p> <p>$9 \div 3 = \square$</p>  <p>$90 \div 3 = \square$</p>  <p>$900 \div 3 = \square$</p>  <p>$9 \div 3 = 3$</p> <p><i>9 tens divided by 3 is 3 tens. 9 hundreds divided by 3 is 3 hundreds.</i></p>	<p>$5 = 35 \div 7$</p> <p>Use known facts to divide 10s and 100s by a single digit.</p> <p>$15 \div 3 = 5$</p> <p>$150 \div 3 = 50$</p> <p>$1500 \div 3 = 500$</p>
<p>Divide by sharing</p>	<p>Share using place value equipment</p> <p><i>36 shared equally between 3 groups</i></p> 	<p>Share by exchanging</p> <p><i>56 shared equally between 4 groups</i></p> <p><i>First share the 10s.</i></p>	<p>Share using known facts and partitioning where appropriate</p> <p>$142 \div 2 = ?$</p>  <p>$100 \div 2 = \square$ $40 \div 2 = \square$ $6 \div 2 = \square$</p> <p>$100 \div 2 = 50$</p>

$$36 \div 3 = 12$$

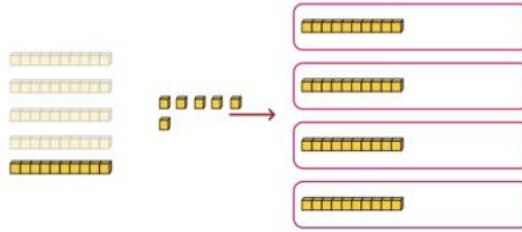

Exchange 1 ten for 1s, then share all the 1s.

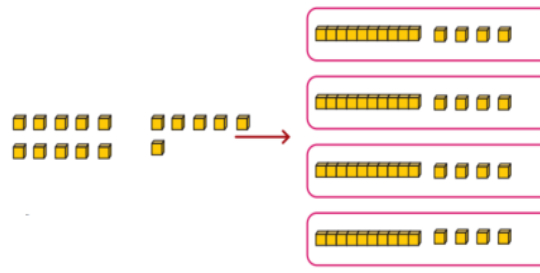

$$40 \div 2 = 20$$

$$6 \div 2 = 3$$

$$50 + 20 + 3 = 73$$

$$142 \div 2 = 71$$

$$56 \div 4 = 14$$

Understanding remainders

Use place value equipment to find remainders.

85 shared into 4 equal groups

There are 24, and 1 that cannot be shared.

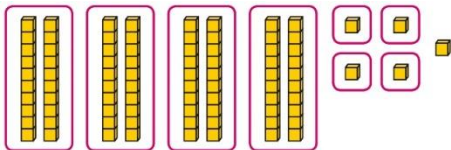

Represent the remainder as the part that cannot be shared equally.

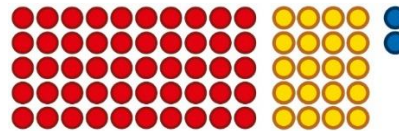

$$72 \div 5 = 14 \text{ remainder } 2$$

Understand how partitioning can reveal remainders of divisions.

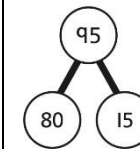

$$80 \div 4 = 20$$

$$12 \div 4 = 3$$

$$95 \div 4 = 23 \text{ remainder } 3$$

***Power Maths White Rose Edition* calculation policy, UPPER KS2**

KEY STAGE 2

In upper Key Stage 2, children build on secure foundations in calculation, and develop fluency, accuracy and flexibility in their approach to the four operations. They work with whole numbers and adapt their skills to work with decimals, and they continue to develop their ability to select appropriate, accurate and efficient operations.

Key language: decimal, column methods, exchange, partition, mental method, ten thousand, hundred thousand, million, factor, multiple, prime number, square number, cube number

Addition and subtraction: Children build on their column methods to add and subtract numbers with up to seven digits, and they adapt the methods to calculate efficiently and effectively with decimals, ensuring understanding of place value at every stage.

Children compare and contrast methods, and they select mental methods or jottings where appropriate and where these are more likely to be efficient or accurate when compared with formal column methods.

Bar models are used to represent the calculations required to solve problems and may indicate where efficient methods can be chosen.

Multiplication and division: Building on their understanding, children develop methods to multiply up to 4-digit numbers by single-digit and 2-digit numbers.

Children develop column methods with an understanding of place value, and they continue to use the key skill of unitising to multiply and divide by 10, 100 and 1,000.

Written division methods are introduced and adapted for division by single-digit and 2-digit numbers and are understood alongside the area model and place value. In Year 6, children develop a secure understanding of how division is related to fractions.

Multiplication and division of decimals are also introduced and refined in Year 6.

Fractions: Children find fractions of amounts, multiply a fraction by a whole number and by another fraction, divide a fraction by a whole number, and add and subtract fractions with different denominators. Children become more confident working with improper fractions and mixed numbers and can calculate with them.

Understanding of decimals with up to 3 decimal places is built through place value and as fractions, and children calculate with decimals in the context of measure as well as in pure arithmetic.

Children develop an understanding of percentages in relation to hundredths, and they understand how to work with common percentages: 50%, 25%, 10% and 1%.

Year 5

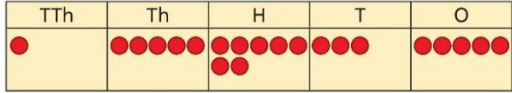
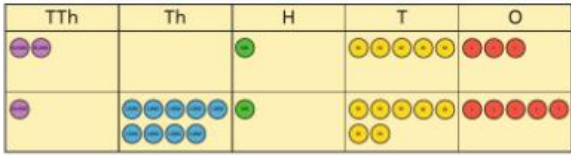
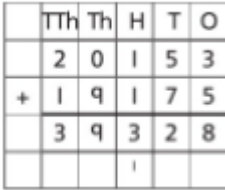
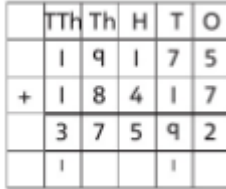
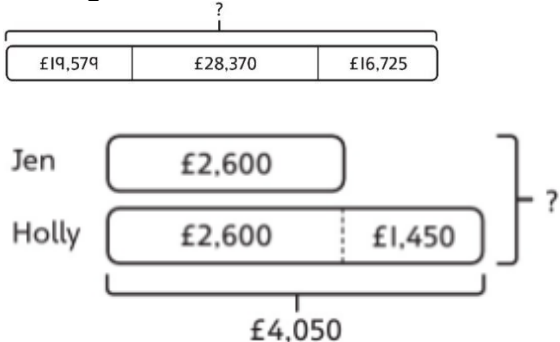
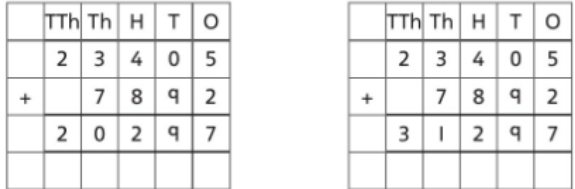
	Concrete	Pictorial	Abstract
Year 5 Addition			
Column addition with whole numbers	<p>Use place value equipment to represent additions.</p>  <p>Add a row of counters onto the place value grid to show $15,735 + 4,012$.</p>	<p>Represent additions, using place value equipment on a place value grid alongside written methods.</p>  <p>I need to exchange 10 tens for a 100.</p> 	<p>Use column addition, including exchanges.</p> 
Representing additions		<p>Bar models represent addition of two or more numbers in the context of problem solving.</p> 	<p>Use approximation to check whether answers are reasonable.</p>  <p>I will use $23,000 + 8,000$ to check.</p>

	Th	H	T	O
	2	6	0	0
+	1	4	5	0
	4	0	5	0

	Th	H	T	O
	2	6	0	0
+	4	0	5	0
	6	6	5	0

Use a bar model with a number line to add tenths.

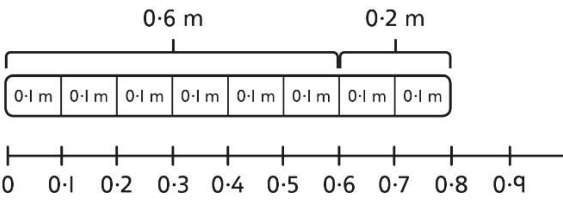

$0.6 + 0.2 = 0.8$
 6 tenths + 2 tenths = 8 tenths

Understand the link with adding fractions.

$\frac{6}{10} + \frac{2}{10} = \frac{8}{10}$
 6 tenths + 2 tenths = 8 tenths
 $0.6 + 0.2 = 0.8$

Use place value equipment on a place value grid to represent additions.

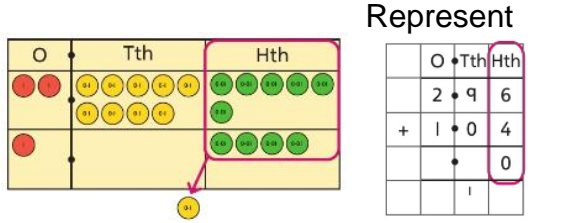

exchange where necessary. Include examples where the numbers of decimal places are different.

Add using a column method, ensuring that children understand the link with place value.

	0	•	Tth	Hth
	0	•	2	3
+	0	•	4	5
	0	•	6	8

Include exchange where required, alongside an understanding of place value.

	0	•	Tth	Hth
	0	•	5	7
+	0	•	4	3
	1	•	0	0
	1			

value.

Adding tenths

Link measure with addition of decimals.

Two lengths of fencing are 0.6 m and 0.2 m. How long are they when added together?



Adding decimals using column addition

Use place value equipment to represent additions.

Show 0.23 + 0.45 using place value counters.

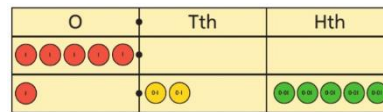

	O	Tth	Hth
	5	0	0
+	1	2	5
	6	2	5

Include additions where the numbers of decimal places are different.

	O	Tth	Hth
	2	3	1
+	0	7	0
		●	

Year 5 Subtraction

Column subtraction with whole numbers

Use place value equipment to understand where exchanges are required.

$$2,250 - 1,070 = ?$$

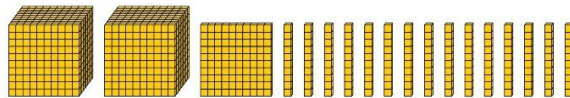

Represent the stages of the calculation using place value equipment on a grid alongside the calculation, including exchanges where required.

$$15,735 - 2,582 = 13,153$$

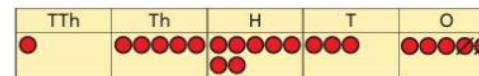

Now subtract the 10s.
Exchange 1 hundred for 10 tens.

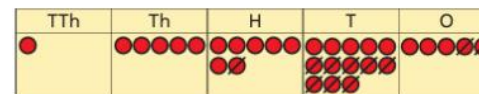

Subtract the 100s, 1,000s and 10,000s.

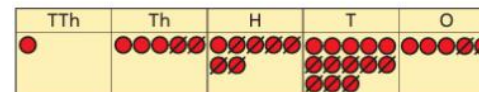

Use column subtraction methods with exchange where required.

	TTh	Th	H	T	O
	15	2	5	9	7
-	1	8	0	3	4
	4	4	5	6	3

$$62,597 - 18,034 = 44,563$$

	TTh	Th	H	T	O
	1	5	7	3	5
-		2	5	8	2
					3

	TTh	Th	H	T	O
	1	5	7	3	5
-		2	5	8	2
				5	3

	TTh	Th	H	T	O
	1	5	7	3	5
-		2	5	8	2
	1	3	1	5	3

Bar models represent subtractions in problem contexts, including 'find the difference'.

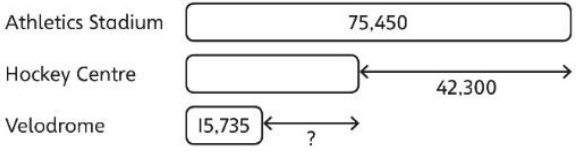

Children can explain the mistake made when the columns have not been ordered correctly.

Use approximation to check calculations.

Bella's working

Correct method

	TTh	Th	H	T	O
	1	7	8	7	7
+	4	0	1	2	
	5	7	9	9	7

	TTh	Th	H	T	O
	1	7	8	7	7
+		4	0	1	2
	2	1	8	8	9

I calculated 18,000 + 4,000 mentally to check my subtraction.

Checking strategies and representing subtractions

Choosing efficient methods

To subtract two large numbers that are close, children find the difference by counting on.

$$2,002 - 1,995 = ?$$

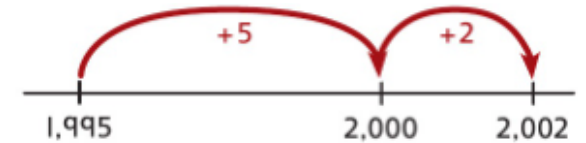

Use addition to check subtractions.

*I calculated $7,546 - 2,355 = 5,191$.
I will check using the inverse.*

Subtracting decimals

Explore complements to a whole number by working in the context of length.



$$1 \text{ m} - \square \text{ m} = \square \text{ m}$$

$$1 - 0.49 = ?$$

Use a place value grid to represent the stages of column subtraction, including exchanges where required.

$$5.74 - 2.25 = ?$$

Use column subtraction, with an understanding of place value, including subtracting numbers with different numbers of decimal places.

$$2.000 - 0.296 = ?$$

	O	Tth	Hth	Thth
	2	0	0	0
-	0	2	9	6
	1	7	0	4



Exchange 1 tenth for 10 hundredths.

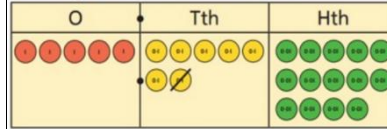

Now subtract the 5 hundredths.

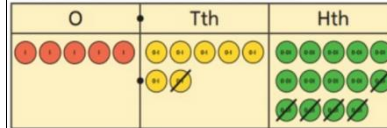

Now subtract the 2 tenths, then the 2 ones.

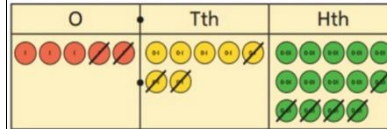

	O	Tth	Hth
	5	7	4
-	2	2	5

	O	Tth	Hth
	5	7	4
-	2	2	5

	O	Tth	Hth
	5	7	4
-	2	2	5
			9

	O	Tth	Hth
	5	7	4
-	2	2	5
	3	4	9

Year 5 Multiplication

Understanding factors

Use cubes or counters to explore the meaning of 'square numbers'.

25 is a square number because it is made from 5 rows of 5.

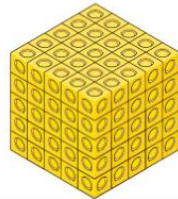

Use images to explore examples and non-examples of square numbers.

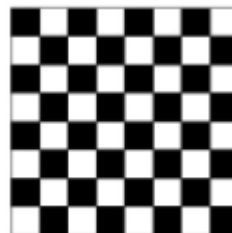

$8 \times 8 = 64$
 $8^2 = 64$

Understand the pattern of square numbers in the multiplication tables.

Use a multiplication grid to circle each square number. Can children spot a pattern?

Use cubes to explore cube numbers.

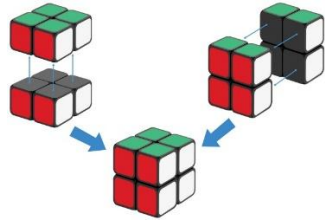

8 is a cube number.

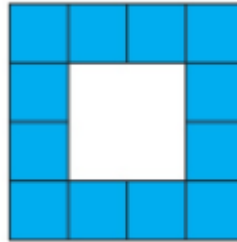

12 is not a square number, because you cannot multiply a whole number by itself to make 12.

Multiplying by 10, 100 and 1,000

Use place value equipment to multiply by 10, 100 and 1,000 by unitising.

$4 \times 1 = 4 \text{ ones} = 4$	
$4 \times 10 = 4 \text{ tens} = 40$	
$4 \times 100 = 4 \text{ hundreds} = 400$	

Understand the effect of repeated multiplication by 10.



$7 \times 10 = 70$

$7 \times 100 = 7,000$

$7 \times 1,000 = 70,000$

Understand how exchange relates to the digits when multiplying by 10, 100 and 1,000.

H	T	O
	1	7

$17 \times 10 = 170$

$17 \times 100 = 17 \times 10 \times 10 = 1,700$

$17 \times 1,000 = 17 \times 10 \times 10 \times 10 = 17,000$

Multiplying by multiples of 10, 100 and 1,000

Use place value equipment to explore multiplying by unitising.

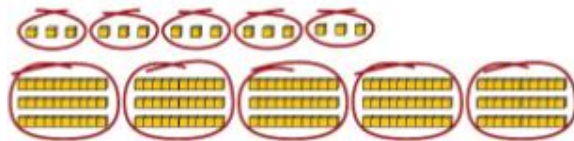

5 groups of 3 ones is 15 ones.

5 groups of 3 tens is 15 tens.

Use place value equipment to represent how to multiply by multiples of 10, 100 and 1,000.

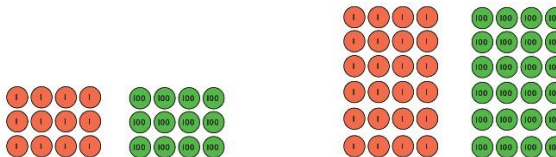

$4 \times 3 = 12$

$6 \times 4 = 24$

Use known facts and unitising to multiply.

$5 \times 4 = 20$

$5 \times 40 = 200$

$5 \times 400 = 2,000$

$5 \times 4,000 = 20,000$

$5,000 \times 4 = 20,000$

So, I know that 5 groups of 3 thousands would be 15 thousands.

$4 \times 300 = 1,200$ $6 \times 400 = 2,400$

Multiplying up to 4-digit numbers by a single digit

Explore how to use partitioning to multiply efficiently.

$8 \times 17 = ?$

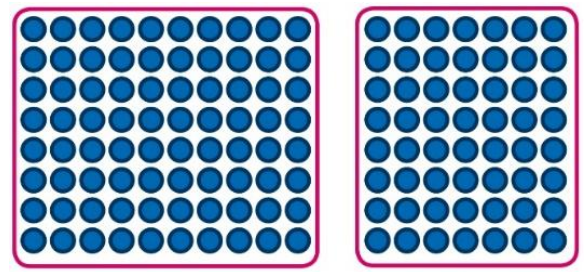

$8 \times 10 = 80$

$8 \times 7 = 56$

$80 + 56 = 136$

So, $8 \times 17 = 136$

Represent multiplications using place value equipment and add the 1s, then 10s, then 100s, then 1,000s.

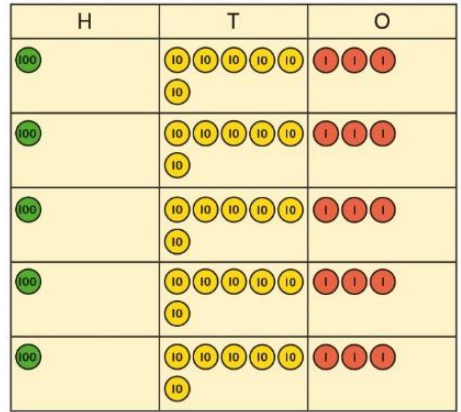

Use an area model and then add the parts.

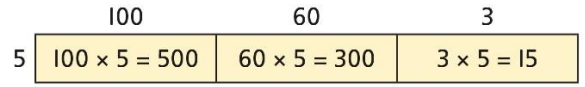

Use a column multiplication, including any required exchanges.

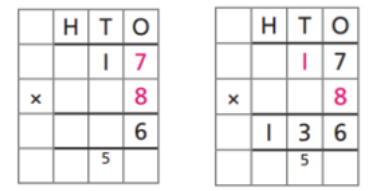

Multiplying 2-digit numbers by 2-digit numbers

Partition one number into 10s and 1s, then add the parts.

$23 \times 15 = ?$

Use an area model and add the parts.

$28 \times 15 = ?$

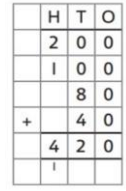
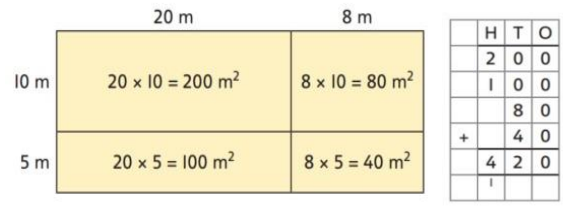

$28 \times 15 = 420$

Use column multiplication, ensuring understanding of place value at each stage.



$10 \times 15 = 150$

$10 \times 15 = 150$



$3 \times 15 = 45$

There are 345 bottles of milk in total.

	H	T	O
	1	5	0
	1	5	0
+		4	5
	3	4	5
			1

$23 \times 15 = 345$

		3	4
x		2	7
	2	3	8
	6	² 8	0
	9	1	8
	¹		

34×7

34×20

34×27

Multiplying up to 4-digits by 2-digits

Use the area model then add the parts.

	100	40	3
10	$100 \times 10 = 1,000$	$40 \times 10 = 400$	$3 \times 10 = 30$
2	$100 \times 2 = 200$	$40 \times 2 = 80$	$3 \times 2 = 6$

	Th	H	T	O
	1	0	0	0
		4	0	0
		2	0	0
			8	0
			3	0
+				6
	1	7	1	6

$143 \times 12 = 1,716$

Use column multiplication, ensuring understanding of place value at each stage.

	Th	H	T	O
		1	4	3
x			1	2
		2	8	6
	1	4	3	0
	1	7	1	6

143×2

143×10

143×12

Progress to include examples that require multiple exchanges as understanding, confidence and fluency build.

$1,274 \times 32 = ?$

First multiply 1,274 by 2.

	TTh	Th	H	T	O
		1	2	7	4
x				3	2
		2	5	4	8

1,274 × 2

Then multiply 1,274 by 30.

	TTh	Th	H	T	O
		1	2	7	4
x				3	2
		2	5	4	8
	3	8	2	2	0
		2	1		

1,274 × 2

1,274 × 30

Finally add up the numbers.

	TTh	Th	H	T	O
		1	2	7	4
x				3	2
		2	5	4	8
	3	8	2	2	0
	4	0	7	6	8

1,274 × 2

1,274 × 30

1,274 × 32

Multiplying decimals by 10, 100 and 1,000

Use place value equipment to explore and understand the exchange of 10 tenths, 10 hundredths or 10 thousandths.

Represent multiplication by 10 as exchange on a place value grid.

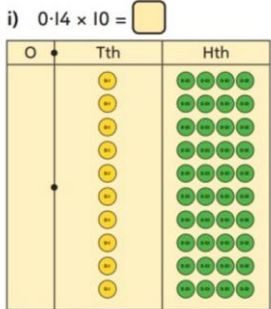

$0.14 \times 10 = 1.4$

Understand how this exchange is represented on a place value chart.

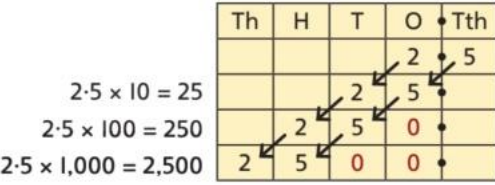

Year 5 Division

Understanding factors and prime numbers

Use equipment to explore the factors of a given number.



$24 \div 3 = 8$
 $24 \div 8 = 3$

8 and 3 are factors of 24 because they divide 24 exactly.

Understand that prime numbers are numbers with exactly two factors.

$13 \div 1 = 13$
 $13 \div 2 = 6 \text{ r } 1$
 $13 \div 4 = 4 \text{ r } 1$



1 and 13 are the only factors of 13. 13 is a prime number.

Understand how to recognise prime and composite numbers.

I know that 31 is a prime number because it can be divided by only 1 and itself without leaving a remainder.

I know that 33 is not a prime number as it can be divided by 1, 3, 11 and 33.

I know that 1 is not a prime number, as it has only 1 factor.

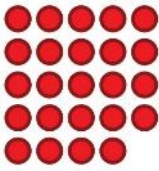
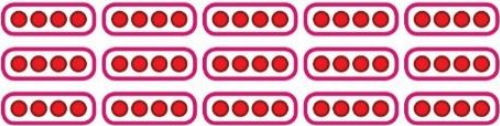
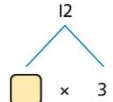
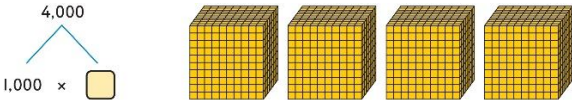
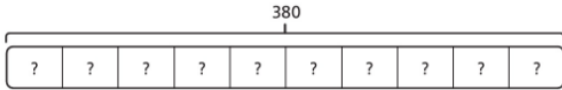
	<p>$24 \div 5 = 4$ remainder 4.</p>  <p><i>5 is not a factor of 24 because there is a remainder.</i></p>										
<p>Understanding inverse operations and the link with multiplication, grouping and sharing</p>	<p>Use equipment to group and share and to explore the calculations that are present.</p> <p><i>I have 28 counters.</i></p> <p><i>I made 7 groups of 4. There are 28 in total.</i></p> <p><i>I have 28 in total. I shared them equally into 7 groups. There are 4 in each group.</i></p> <p><i>I have 28 in total. I made groups of 4. There are 7 equal groups.</i></p>	<p>Represent multiplicative relationships and explore the families of division facts.</p>  <p>$60 \div 4 = 15$ $60 \div 15 = 4$</p>	<p>Represent the different multiplicative relationships to solve problems requiring inverse operations.</p> <p>$12 \div 3 = \square$ $12 \div \square = 3$ $\square \times 3 = 12$ $\square \div 3 = 12$</p>  <p>Understand missing number problems for division calculations and know how to solve them using inverse operations.</p> <p>$22 \div ? = 2$ $22 \div 2 = ?$ $? \div 2 = 22$ $? \div 22 = 2$</p>								
<p>Dividing whole numbers by 10, 100 and 1,000</p>	<p>Use place value equipment to support unitising for division.</p> <p>$4,000 \div 1,000$</p>  <p><i>4,000 is 4 thousands.</i></p>	<p>Use a bar model to support dividing by unitising.</p> <p>$380 \div 10 = 38$</p> 	<p>Understand how and why the digits change on a place value grid when dividing by 10, 100 or 1,000.</p> <table border="1" data-bbox="1563 1241 2123 1343"> <thead> <tr> <th>Th</th> <th>H</th> <th>T</th> <th>O</th> </tr> </thead> <tbody> <tr> <td>3</td> <td>2</td> <td>0</td> <td>0</td> </tr> </tbody> </table> <p>$3,200 \div 100 = ?$</p>	Th	H	T	O	3	2	0	0
Th	H	T	O								
3	2	0	0								

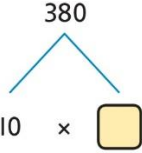
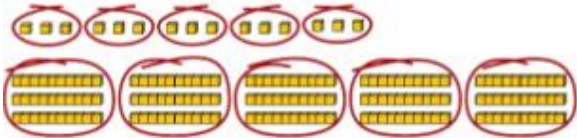
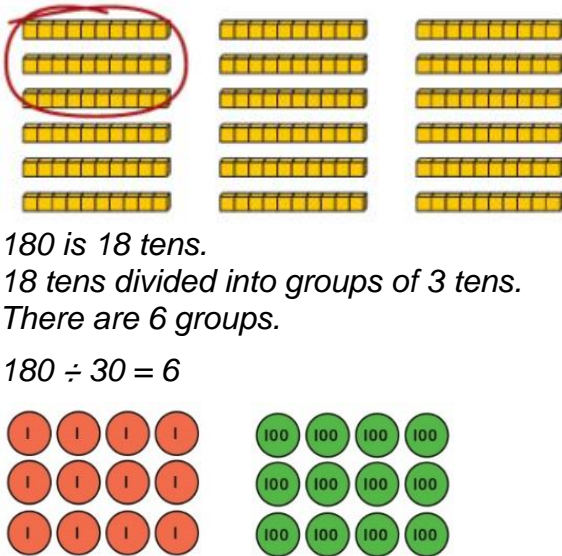
	<p>$4 \times 1,000 = 4,000$</p> <p>So, $4,000 \div 1,000 = 4$</p>	<p style="text-align: center;">380</p>  <p>$10 \times \square$</p> <p><i>380 is 38 tens.</i> $38 \times 10 = 380$ $10 \times 38 = 380$ So, $380 \div 10 = 38$</p>	<p><i>3,200 is 3 thousands and 2 hundreds.</i></p> <p>$200 \div 100 = 2$ $3,000 \div 100 = 30$ $3,200 \div 100 = 32$</p> <p><i>So, the digits will move two places to the right.</i></p>
<p>Dividing by multiples of 10, 100 and 1,000</p>	<p>Use place value equipment to represent known facts and unitising.</p>  <p><i>15 ones put into groups of 3 ones. There are 5 groups.</i> $15 \div 3 = 5$</p> <p><i>15 tens put into groups of 3 tens. There are 5 groups.</i> $150 \div 30 = 5$</p>	<p>Represent related facts with place value equipment when dividing by unitising.</p>  <p><i>180 is 18 tens.</i> <i>18 tens divided into groups of 3 tens. There are 6 groups.</i> $180 \div 30 = 6$</p> <p><i>12 ones divided into groups of 4. There are 3 groups.</i> <i>12 hundreds divided into groups of 4 hundreds. There are 3 groups.</i> $1200 \div 400 = 3$</p>	<p>Reason from known facts, based on understanding of unitising. Use knowledge of the inverse relationship to check.</p> <p>$3,000 \div 5 = 600$ $3,000 \div 50 = 60$ $3,000 \div 500 = 6$</p> <p>$5 \times 600 = 3,000$ $50 \times 60 = 3,000$ $500 \times 6 = 3,000$</p>

Dividing up to four digits by a single digit using short division

Explore grouping using place value equipment.

$$268 \div 2 = ?$$

*There is 1 group of 2 hundreds.
There are 3 groups of 2 tens.
There are 4 groups of 2 ones.*

$$264 \div 2 = 134$$

Use place value equipment on a place value grid alongside short division.

The model uses grouping. A sharing model can also be used, although the model would need adapting.

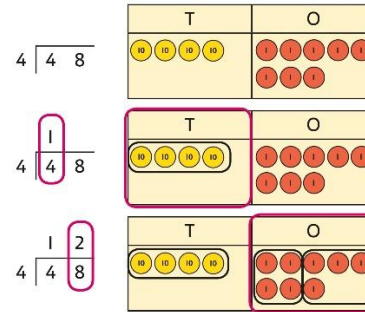

Lay out the problem as a short division.

*There is 1 group of 4 in 4 tens.
There are 2 groups of 4 in 8 ones.*

Work with divisions that require exchange.

Use short division for up to 4-digit numbers divided by a single digit.

		0	5	5	6	
	7	3	³ 8	³ 9	⁴ 2	

$$3,892 \div 7 = 556$$

Use multiplication to check.

$$556 \times 7 = ?$$

$$6 \times 7 = 42$$

$$50 \times 7 = 350$$

$$500 \times 7 = 3500$$

$$3,500 + 350 + 42 = 3,892$$

2 ones are 20 tenths.
 20 tenths divided by 10 is 2 tenths.

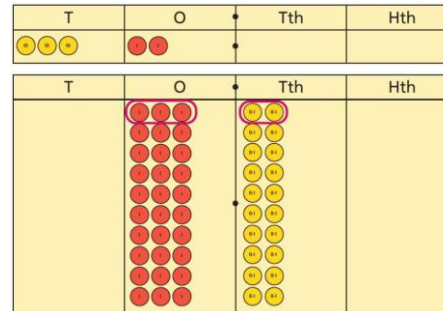

32 is 3 tens and 2 ones.
 This is equivalent to 30 ones and 20 tenths.
 30 ones divided by 10 is 3 ones.
 20 tenths divided by 10 is 2 tenths.
 32 divided by 10 is 3.2.

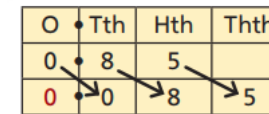

$$0.85 \div 10 = 0.085$$

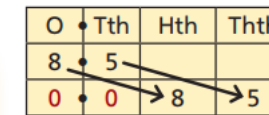

$$8.5 \div 100 = 0.085$$

Understanding the relationship between fractions and division

Use sharing to explore the link between fractions and division.

1 whole shared between 3 people.
 Each person receives one-third.

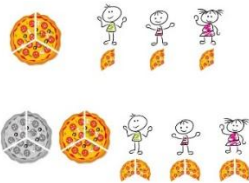

Use a bar model and other fraction representations to show the link between fractions and division.



$$1 \div 3 = \frac{1}{3}$$

Use the link between division and fractions to calculate divisions.

$$5 \div 4 = \frac{5}{4} = 1\frac{1}{4}$$

$$11 \div 4 = \frac{11}{4} = 2\frac{3}{4}$$

Year 6

Concrete

Pictorial

Abstract

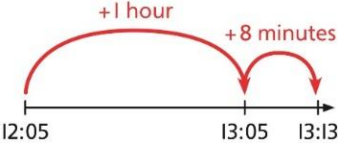
Year 6 Addition																																																																																																																							
<p>Comparing and selecting efficient methods</p>	<p>Represent 7-digit numbers on a place value grid and use this to support thinking and mental methods.</p> <table border="1" data-bbox="353 360 927 427"> <tr> <th>M</th> <th>HTh</th> <th>TTh</th> <th>Th</th> <th>H</th> <th>T</th> <th>O</th> </tr> <tr> <td>●●</td> <td>●●●●</td> <td>●</td> <td>●</td> <td>●●●</td> <td></td> <td>●</td> </tr> </table>	M	HTh	TTh	Th	H	T	O	●●	●●●●	●	●	●●●		●	<p>Discuss similarities and differences between methods, and choose efficient methods based on the specific calculation.</p> <p>Compare written and mental methods alongside place value representations.</p> <div style="display: flex; justify-content: space-around; align-items: center;"> <div data-bbox="958 504 1196 596"> <p style="text-align: center;">?</p> <table border="1" style="margin: auto;"> <tr><td>40,365</td><td>3,572</td></tr> </table> </div> <div data-bbox="1303 485 1518 663"> <table border="1" style="text-align: center;"> <tr><th>TTh</th><th>Th</th><th>H</th><th>T</th><th>O</th></tr> <tr><td>4</td><td>0</td><td>3</td><td>6</td><td>5</td></tr> <tr><td>+</td><td></td><td>3</td><td>5</td><td>7</td></tr> <tr><td></td><td></td><td></td><td></td><td></td></tr> <tr><td></td><td></td><td></td><td></td><td></td></tr> </table> </div> </div> <p>Use bar model and number line representations to model addition in problem-solving and measure contexts.</p> <div style="text-align: center;">  </div>	40,365	3,572	TTh	Th	H	T	O	4	0	3	6	5	+		3	5	7											<p>Use column addition where mental methods are not efficient. Recognise common errors with column addition.</p> <p>$17,877 + 4,012 = ?$</p> <div style="display: flex; justify-content: space-around;"> <table border="1" data-bbox="1563 437 1809 644"> <tr><th>TTh</th><th>Th</th><th>H</th><th>T</th><th>O</th></tr> <tr><td>1</td><td>7</td><td>8</td><td>7</td><td>7</td></tr> <tr><td>+</td><td>4</td><td>0</td><td>1</td><td>2</td></tr> <tr><td></td><td>5</td><td>7</td><td>9</td><td>9</td></tr> <tr><td></td><td></td><td></td><td></td><td></td></tr> </table> <table border="1" data-bbox="1877 437 2123 644"> <tr><th>TTh</th><th>Th</th><th>H</th><th>T</th><th>O</th></tr> <tr><td>1</td><td>7</td><td>8</td><td>7</td><td>7</td></tr> <tr><td>+</td><td></td><td>4</td><td>0</td><td>1</td></tr> <tr><td></td><td>2</td><td>1</td><td>8</td><td>8</td></tr> <tr><td></td><td></td><td></td><td></td><td></td></tr> </table> </div> <p><i>Which method has been completed accurately?</i></p> <p><i>What mistake has been made?</i></p> <p>Column methods are also used for decimal additions where mental methods are not efficient.</p> <table border="1" data-bbox="1568 1098 1783 1273"> <tr><th>H</th><th>T</th><th>O</th><th>TTh</th><th>Hth</th></tr> <tr><td>1</td><td>4</td><td>0</td><td>0</td><td>9</td></tr> <tr><td>+</td><td></td><td>4</td><td>9</td><td>8</td></tr> <tr><td></td><td>1</td><td>8</td><td>9</td><td>8</td></tr> <tr><td></td><td></td><td></td><td></td><td></td></tr> </table>	TTh	Th	H	T	O	1	7	8	7	7	+	4	0	1	2		5	7	9	9						TTh	Th	H	T	O	1	7	8	7	7	+		4	0	1		2	1	8	8						H	T	O	TTh	Hth	1	4	0	0	9	+		4	9	8		1	8	9	8					
M	HTh	TTh	Th	H	T	O																																																																																																																	
●●	●●●●	●	●	●●●		●																																																																																																																	
40,365	3,572																																																																																																																						
TTh	Th	H	T	O																																																																																																																			
4	0	3	6	5																																																																																																																			
+		3	5	7																																																																																																																			
TTh	Th	H	T	O																																																																																																																			
1	7	8	7	7																																																																																																																			
+	4	0	1	2																																																																																																																			
	5	7	9	9																																																																																																																			
TTh	Th	H	T	O																																																																																																																			
1	7	8	7	7																																																																																																																			
+		4	0	1																																																																																																																			
	2	1	8	8																																																																																																																			
H	T	O	TTh	Hth																																																																																																																			
1	4	0	0	9																																																																																																																			
+		4	9	8																																																																																																																			
	1	8	9	8																																																																																																																			
<p>Selecting mental methods for larger</p>	<p>Represent 7-digit numbers on a place value grid and use this to support thinking and mental methods.</p>	<p>Use a bar model to support thinking in addition problems.</p> <p>$257,000 + 99,000 = ?$</p>	<p>Use place value and unitising to support mental calculations with larger numbers.</p> <p>$195,000 + 6,000 = ?$</p>																																																																																																																				

numbers where appropriate



$$2,411,301 + 500,000 = ?$$

This would be 5 more counters in the HTh place.

So, the total is 2,911,301.

$$2,411,301 + 500,000 = 2,911,301$$

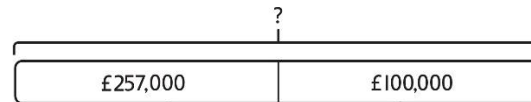

I added 100 thousands then subtracted 1 thousand.

257 thousands + 100 thousands = 357 thousands

$$257,000 + 100,000 = 357,000$$

$$357,000 - 1,000 = 356,000$$

So, 257,000 + 99,000 = 356,000

$$195 + 5 + 1 = 201$$

195 thousands + 6 thousands = 201 thousands

So, 195,000 + 6,000 = 201,000

Understanding order of operations in calculations

Use equipment to model different interpretations of a calculation with more than one operation. Explore different results.

$$3 \times 5 - 2 = ?$$

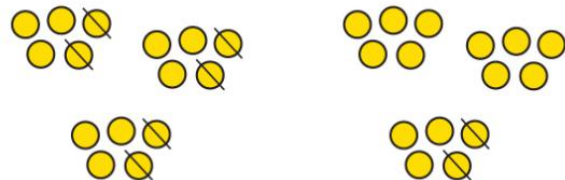

$$3 \times (5 - 2)$$

$$\downarrow \quad \downarrow$$

$$3 \times 3 = 9$$

$$(3 \times 5) - 2$$

$$\downarrow \quad \downarrow$$

$$15 - 2 = 13$$

Model calculations using a bar model to demonstrate the correct order of operations in multi-step calculations.

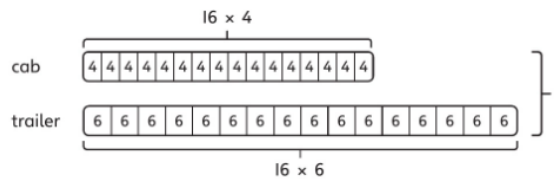

This can be written as: $16 \times 4 + 16 \times 6$

$$16 \times 4 + 16 \times 6$$

$$64 + 96 = 160$$

Understand the correct order of operations in calculations without brackets.

Understand how brackets affect the order of operations in a calculation.

$$4 + 6 \times 16$$

$$4 + 96 = 100$$

$$(4 + 6) \times 16$$

$$10 \times 16 = 160$$

Year 6 Subtraction

Comparing and selecting efficient methods

Use counters on a place value grid to represent subtractions of larger numbers.

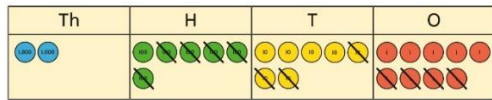

Compare subtraction methods alongside place value representations.

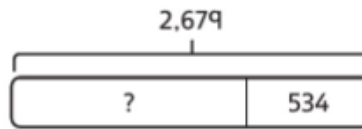

	Th	H	T	O
	2	6	7	9
-		5	3	4
	2	1	4	5



Use a bar model to represent calculations, including 'find the difference' with two bars as comparison.

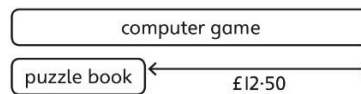

Compare and select methods. Use column subtraction when mental methods are not efficient. Use two different methods for one calculation as a checking strategy.

	Th	H	T	O
	2	6	8	2
-		8	7	5
	1	8	1	7

Use column subtraction for decimal problems, including in the context of measure.

	H	T	O	Tth	Hth
	3	0	9	6	0
-	2	0	6	4	0
	1	0	3	2	0

Subtracting mentally with larger numbers

Use a bar model to show how unitising can support mental calculations.

$950,000 - 150,000$
That is 950 thousands - 150 thousands

So, the difference is 800 thousands.
 $950,000 - 150,000 = 800,000$

Subtract efficiently from powers of 10.
 $10,000 - 500 = ?$

Year 6 Multiplication

Multiplying up to a 4-digit number by a single digit number

Use equipment to explore multiplications.

4 groups of 2,345

This is a multiplication:

$$4 \times 2,345$$

$$2,345 \times 4$$

Use place value equipment to compare methods.

Method 1

Method 2

Understand area model and short multiplication.

Compare and select appropriate methods for specific multiplications.

Method 3

$12,000 + 800 + 80 + 20 = 12,900$

Method 4

Multiplying up to a 4-digit number by a

Use an area model alongside written multiplication.

Use an area model alongside written multiplication.

Use compact column multiplication with understanding of place value at all stages.

2-digit number

	200	30	5
20	4,000	600	100
1	200	30	5

$4,200 + 630 + 105 = 4,935$

		2	3	5	
x		2	1		
				5	1×5
			3	0	1×30
		2	0	0	1×200
		1	0	0	20×5
		6	0	0	20×30
	4	0	0	0	20×300
	4	9	3	5	21×235

			2	3	5		
	x			2	1		
				2	3	5	1×235
			4	7	0	0	20×235
			4	9	3	5	21×235

Using knowledge of factors and partitions to compare methods for multiplication

Use equipment to understand square numbers and cube numbers.

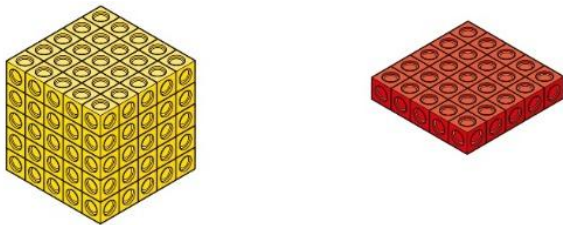

$5 \times 5 = 5^2 = 25$
 $5 \times 5 \times 5 = 5^3 = 25 \times 5 = 125$

Compare methods visually using an area model. Understand that multiple approaches will produce the same

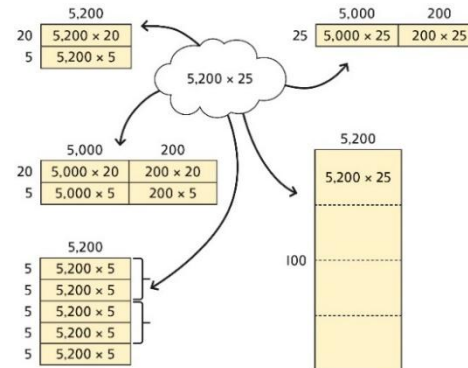

answer if completed accurately. Represent and compare methods using a bar model.

Use a known fact to generate families of related facts.

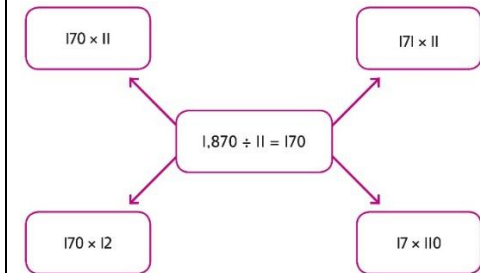

Use factors to calculate efficiently.

15×16
 $= 3 \times 5 \times 2 \times 8$
 $= 3 \times 8 \times 2 \times 5$

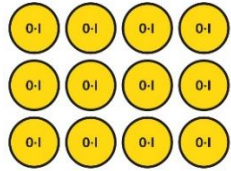

3 groups of 4 tenths is 12 tenths.
4 groups of 3 tenths is 12 tenths.

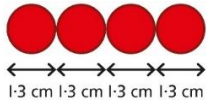

$4 \times 1 \text{ cm} = 4 \text{ cm}$
 $4 \times 0.3 \text{ cm} = 1.2 \text{ cm}$
 $4 \times 1.3 = 4 + 1.2 = 5.2 \text{ cm}$

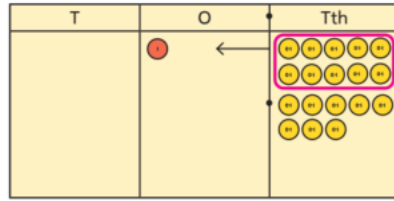

Understand the link between multiplying decimals and repeated addition.

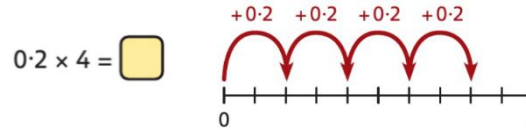

$0.2 \times 4 =$

$20 \times 0.5 = 10$
 $20 \times 0.05 = 1$

Find families of facts from a known multiplication.

I know that $18 \times 4 = 72$.

This can help me work out:

$1.8 \times 4 = ?$
 $18 \times 0.4 = ?$
 $180 \times 0.4 = ?$
 $18 \times 0.04 = ?$

Use a place value grid to understand the effects of multiplying decimals.

	H	T	O	Tth	Hth
2×3			6		
0.2×3			0	6	
0.02×3					

**Year 6
Division**

Understanding factors

Use equipment to explore different factors of a number.

Recognise prime numbers as numbers having exactly two factors. Understand the link with division and remainders.

Recognise and know primes up to 100. Understand that 2 is the only even prime, and that 1 is not a prime number.

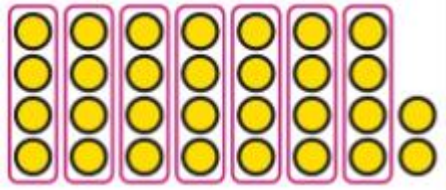
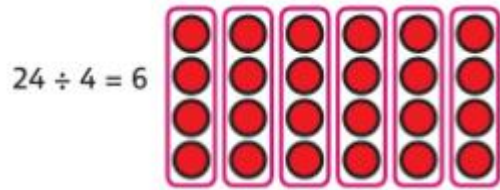

$30 \div 4 = 7 \text{ remainder } 2$

4 is a factor of 24 but is not a factor of 30.

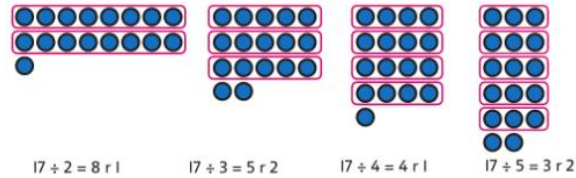

1	2	3	4	5	6	7	8	9	10
11	12	13	14	15	16	17	18	19	20
21	22	23	24	25	26	27	28	29	30
31	32	33	34	35	36	37	38	39	40
41	42	43	44	45	46	47	48	49	50

Dividing by a single digit

Use equipment to make groups from a total.

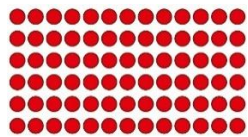

*There are 78 in total.
There are 6 groups of 13.
There are 13 groups of 6.*

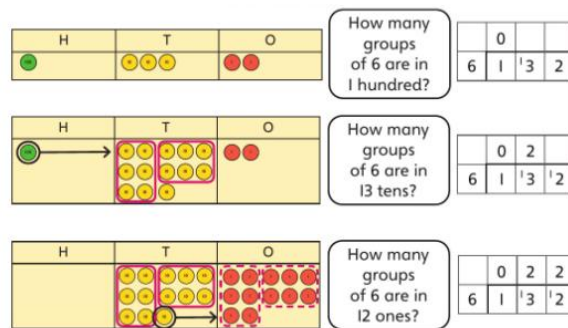

Use short division to divide by a single digit.

	0			
6	1	3	2	

	0	2		
6	1	3	2	

	0	2	2	
6	1	3	2	

Use an area model to link multiplication and division.

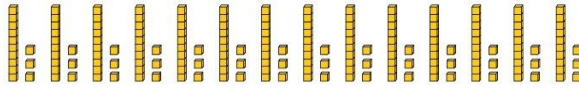
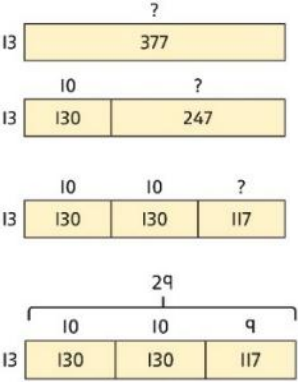
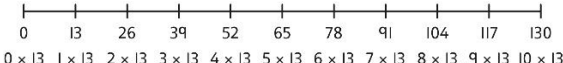
			$6 \overline{) 132}$ $6 \times ? = 132$ <table border="1" style="display: inline-table; margin: 10px;"> <tr><td>10</td><td>10</td><td>1</td><td>1</td></tr> <tr><td>60</td><td>60</td><td>6</td><td>6</td></tr> </table> <table border="1" style="display: inline-table; margin: 10px;"> <tr><td>20</td><td>2</td></tr> <tr><td>120</td><td>12</td></tr> </table> $132 = 120 + 12$ $132 \div 6 = 20 + 2 = 22$	10	10	1	1	60	60	6	6	20	2	120	12
10	10	1	1												
60	60	6	6												
20	2														
120	12														
Dividing by a 2-digit number using factors	Understand that division by factors can be used when dividing by a number that is not prime.	Use factors and repeated division. $1,260 \div 14 = ?$  $1,260 \div 2 = 630$ $630 \div 7 = 90$ $1,260 \div 14 = 90$	Use factors and repeated division where appropriate. $2,100 \div 12 = ?$ $2,100 \rightarrow \boxed{\div 2} \rightarrow \boxed{\div 6} \rightarrow$ $2,100 \rightarrow \boxed{\div 6} \rightarrow \boxed{\div 2} \rightarrow$ $2,100 \rightarrow \boxed{\div 3} \rightarrow \boxed{\div 4} \rightarrow$ $2,100 \rightarrow \boxed{\div 4} \rightarrow \boxed{\div 3} \rightarrow$ $2,100 \rightarrow \boxed{\div 3} \rightarrow \boxed{\div 2} \rightarrow \boxed{\div 2} \rightarrow$												
Dividing by a 2-digit number using long division	Use equipment to build numbers from groups.  182 divided into groups of 13 . There are 14 groups.	Use an area model alongside written division to model the process. $377 \div 13 = ?$  $377 \div 13 = 29$	Use long division where factors are not useful (for example, when dividing by a 2-digit prime number). Write the required multiples to support the division process. $377 \div 13 = ?$ 												

		2	9	
13	3	7	7	
-	1	3	0	10
	2	4	7	
-	1	3	0	10
	1	7	7	
-	1	7	7	9
			0	

$$377 \div 13 = 29$$

A slightly different layout may be used, with the division completed above rather

$$\begin{array}{r} 3 \\ 21 \overline{) 798} \\ - 630 \\ \hline 168 \end{array}$$

$$\begin{array}{r} 38 \\ 21 \overline{) 798} \\ - 630 \\ \hline 168 \\ - 168 \\ \hline 0 \end{array}$$

than at the side.

Divisions with a remainder explored in problem-solving contexts.

Dividing by 10, 100 and 1,000

Use place value equipment to explore division as exchange.

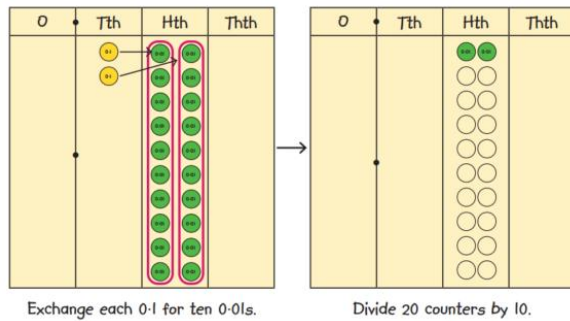

0.2 is 2 tenths.
 2 tenths is equivalent to 20 hundredths.
 20 hundredths divided by 10 is 2 hundredths.

Represent division to show the relationship with multiplication. Understand the effect of dividing by 10, 100 and 1,000 on the digits on a place value grid.

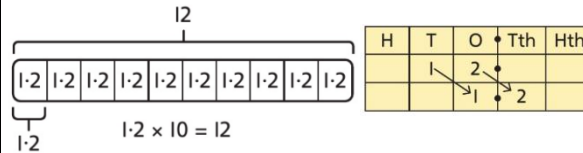

Understand how to divide using division by 10, 100 and 1,000.

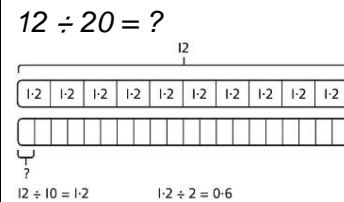

Use knowledge of factors to divide by multiples of 10, 100 and 1,000.

$$40 \div 50 = \square$$

$$40 \rightarrow \div 10 \rightarrow \div 5 \rightarrow ?$$

$$40 \rightarrow \div 5 \rightarrow \div 10 \rightarrow ?$$

$$40 \div 5 = 8$$

$$8 \div 10 = 0.8$$

So, $40 \div 50 = 0.8$

Dividing decimals

Use place value equipment to explore division of decimals.

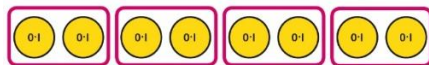

8 tenths divided into 4 groups. 2 tenths in each group.

Use a bar model to represent divisions.

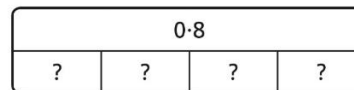

$$4 \times 2 = 8$$

$$8 \div 4 = 2$$

So, $4 \times 0.2 = 0.8$ $0.8 \div 4 = 0.2$

Use short division to divide decimals with up to 2 decimal places.

$$\begin{array}{r} 8 \overline{) 4.24} \\ \underline{4} \\ 0 \\ \underline{0} \\ 0 2 \\ \underline{0} 2 \\ 0 0 \end{array}$$

$$\begin{array}{r} 8 \overline{) 4.424} \\ \underline{4} \\ 0 \\ \underline{0} \\ 0 4 \\ \underline{0} 4 \\ 0 0 \end{array}$$

$$\begin{array}{r} 8 \overline{) 4.53} \\ \underline{4} \\ 0 \\ \underline{0} \\ 0 5 \\ \underline{0} 5 \\ 0 0 \end{array}$$