

Cooking club: Chocolate Strawberries and bananas



Tasneem and Tanaha 9X



Mudrika 8K



Zunairah and Tanisha 8R



Janavi 9X



Ria 9X



Janvi 9X

Year 9: Jamaican patties



Nikki 9S

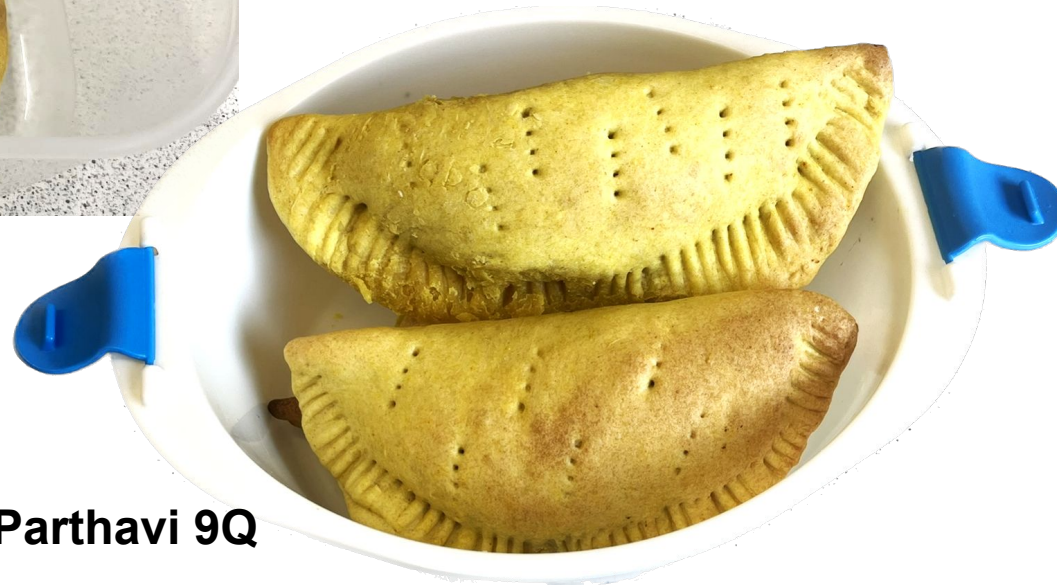

Parthavi 9Q

Year 9: Fresh pasta and Ragu sauce



Kirtan 9Q



Parthavi 9Q



Drashti 9N



Disha 9R

Year 9: Fresh pasta and Ragu sauce



Mansi 9K



Brigitta 9L



Iksir 9L

Year 8: Fried Noodles



Amar 8Q



Tanisha 8R

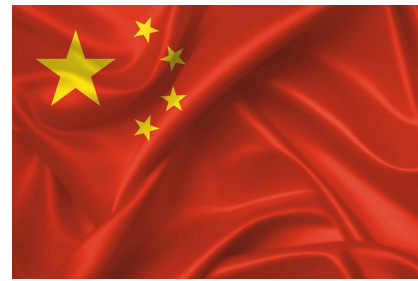

Hetali 8Q



Tiana 8R



Klaudia 8R

Year 7: Pizza toast



Eesa 7P



Drashti 7P



Mohamed 7V



Rasvanti 7N



Lajos 7N

Cooking club: Garlic bread



Ria and Leen 9X



Mudrika 8K



Zunairah 8R



Tanisha 8R



Yashica 8K



Tasneem and Tanaha 9X

Annlin

Year 10 waistcoats



Year 10 waistcoats

Andreea



Ishwari

Year 10 waistcoats



Vanshika

Year 10 waistcoats



Sahana

Year 10 waistcoats



Year 10 waistcoats

Anisha



Krish

Year 10 waistcoats



Brandon

Year 10 waistcoats



Year 8 Night Light Project

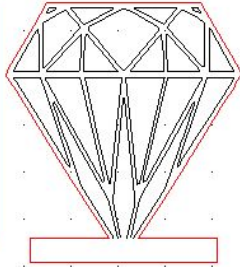
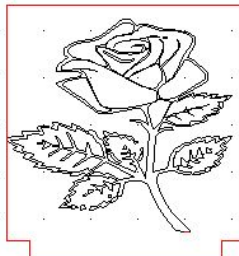
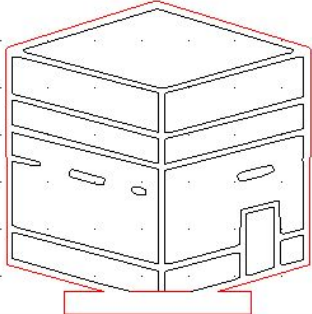
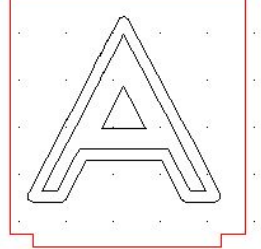
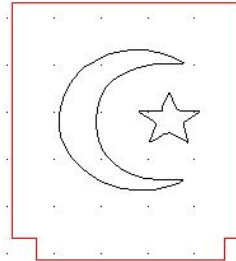
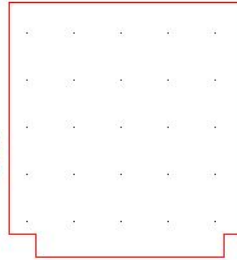
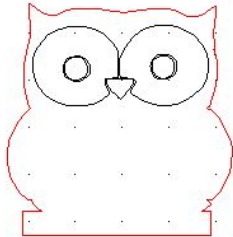
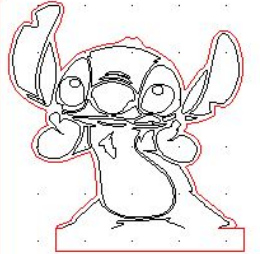
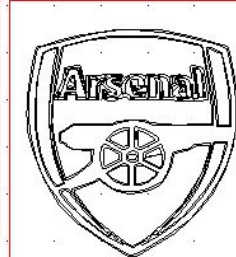
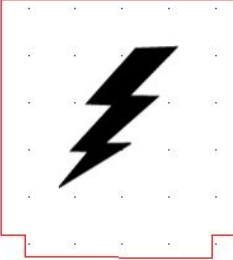
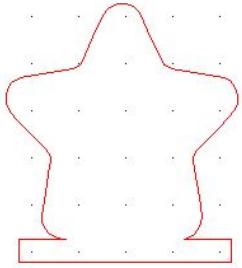

8QR PD
Computer Aided Designing.

Year 8 Night Light Project

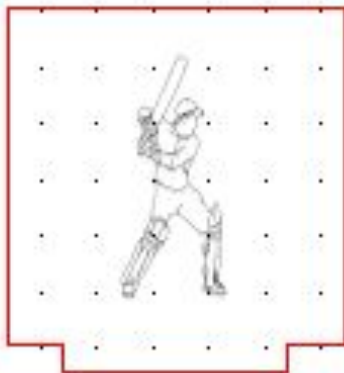

8QR PD Computer Aided Designing.

Year 7 Desk Vase

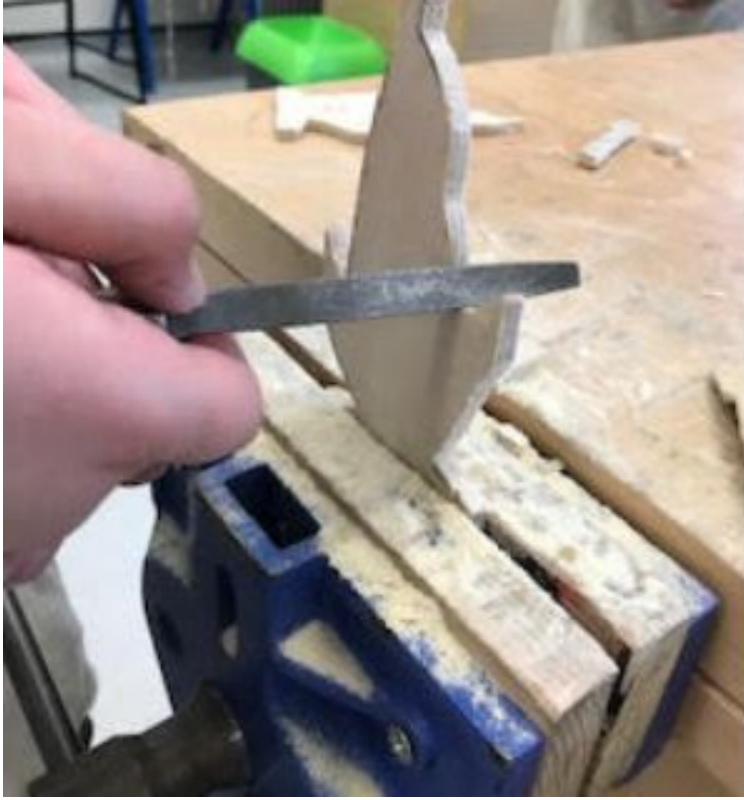

Shaheem 7K Excellent filing skills.



Darren 7K Excellent cutting skills

Year 7 Desk Vase

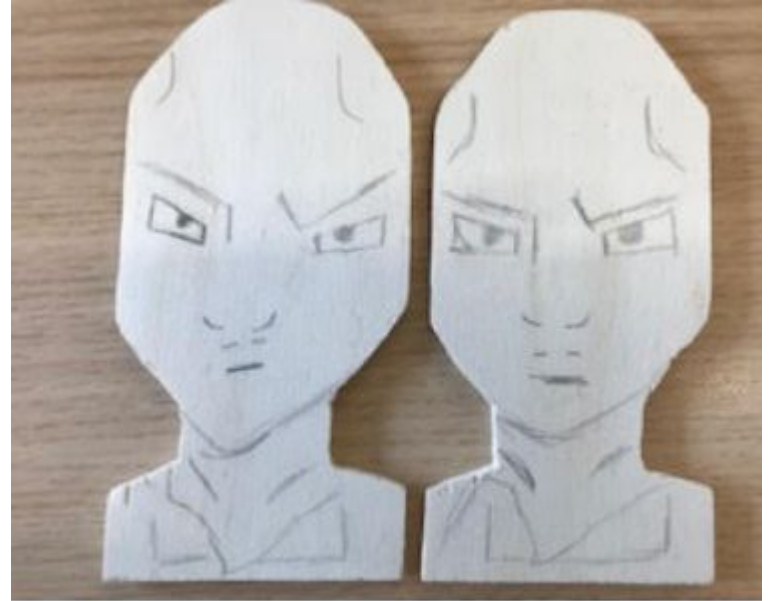

Henil 7W

Excellent skills at cutting wood

Year 7 Desk Vase

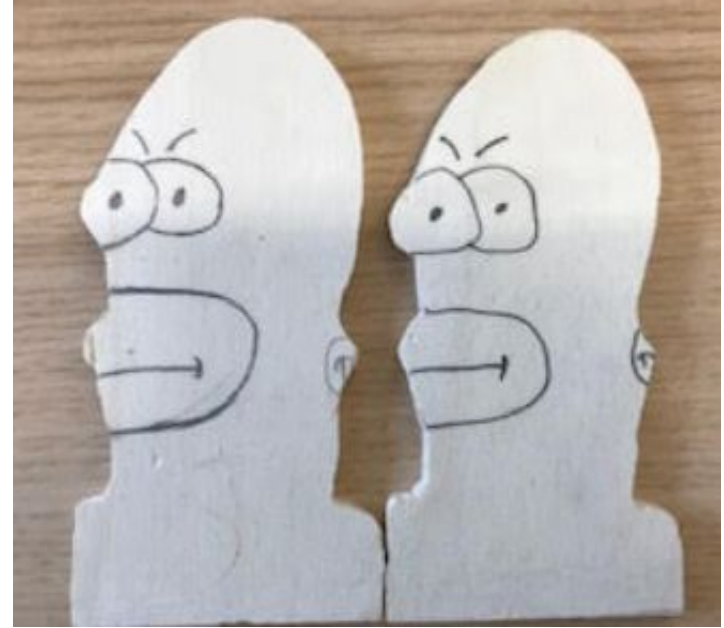

Melvis 7W
Excellent skills at cutting and filing
wood